

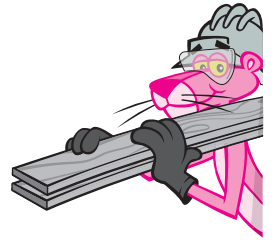

LUMBER

STRUCTURAL FRAMING



STRUCTURAL FRAMING FOR DECK CONSTRUCTION INSTALLATION GUIDE

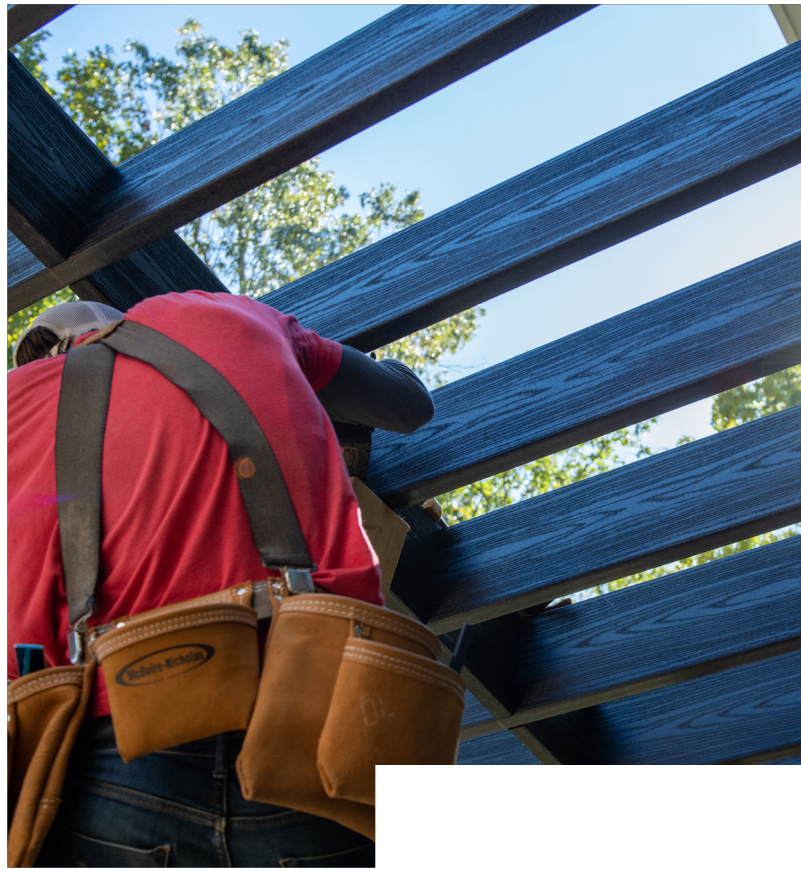

OWENS CORNING® LUMBER STRUCTURAL FRAMING FOR DECK CONSTRUCTION INSTALLATION GUIDE

GENERAL INFORMATION: PAGES 3–4

Safety
Installation and Maintenance Tips
Warranty Information
Materials
Spans and Spacing

INSTALLATION STEPS: PAGES 5–13

Step 1: Install 2x OC™ Lumber Ledger
Step 2: Assemble Posts
Step 3: Assemble Beam(s)
Step 4: Install Drop Beam(s) on Posts
Step 5: Install OC™ Lumber Joists
Step 6: Add Mid-Span and Bearing Blocking
Step 7: Attach Front Rim Joist
Step 8: Install Deck Boards

Owens Corning™ Lumber

5111 S. Pine Ave. #G
Ocala, FL 34480 USA
855.909.9501

[owenscorning.com/lumber](https://www.owenscorning.com/lumber)



HOW WE
BUILD NOW™

SAFETY CONSIDERATIONS

When handling OC™ Lumber products, make sure to wear gloves. Wash skin with soap and water after handling to avoid irritation.

Download our Safety Data Sheets at [owenscorning.com/lumber](https://www.owenscorning.com/lumber) for more information. Available in English, Spanish, and Canadian French.

INSTALLATION TIPS

- **Job Site Storage:** Store OC™ Lumber products on a flat, level surface with supports every two feet. Avoid laying loose boards on uneven surfaces or leaning boards, as they may, like all composites, tend to bend toward that surface particularly in the high heat of summer.
- **Directional Lines:** A raised line runs end to end on one side of each board. When installing, ensure all directional lines face the same direction for a uniform deck.
- **Screw Lines and Markings:** DO NOT USE PENCIL ON OC™ Lumber products. Use a blue chalk line or a blue wax-coated carpenter pencil. Red chalk is not advised as it is difficult to remove.
- **Screws:** Stainless steel composite deck screws are recommended. They resist rust and use reverse threading.
- **Minimum Screw Lengths:**
 - 2.5" Screws for 5/4 x 8"
 - 1.5" Screws for 1/2 x 6", 1/2 x 10"
- **Minimum Spacing:**
 - End to end: 1/16" (3/16" recommended)
 - Side to side: 1/16" (3/16" recommended)
- **Cutting:**
 - Chop Saw: 40T Blade
 - Jig Saw: 14 TPI Carbide

MAINTENANCE TIPS

- **Basic Maintenance:** For regular cleaning, sweep or brush away dirt and debris. Use a pressure cleaner or soap, water, and a scrub brush.
- **Pressure Washing:** Begin 18 inches away from the deck surface with a pressure washer. Move closer using best judgment after first testing a small, inconspicuous area.
- **Tougher Marks:** Spray the affected area with a cleaning solution like Simple Green® or Soft Scrub®. Let cleaners sit for a few minutes, then scrub or pressure wash the area.
- **Rust:** Use a liquid rust remover to remove rust marks from boards.

WARRANTY

- Limited lifetime warranty – Residential
 - 25-Year limited warranty – Commercial
- Visit [owenscorning.com/lumber](https://www.owenscorning.com/lumber) for more information.



RECOMMENDATIONS: MATERIALS, SPANS, AND SPACING

TABLE 1: MAX. ALLOWABLE JOIST SPANS

Fasteners

- #10 x 3" Stainless steel composite deck screws or triple-coated exterior deck screws
- #9 x 2.5" Stainless steel composite deck screws or triple-coated exterior deck screws
- #9 x 1.5" Exterior grade connector screws
- Beam-to-post connectors with a minimum uplift capacity of 2,000 lbs

Joist-to-Ledger Connections

- Double 2x6 joist hangers with minimum gravity capacity of 685 lbs
- Double 2x8 joist hangers with minimum gravity capacity of 980 lbs
- Double 2x10 joist hangers with minimum gravity capacity of 1,170 lbs
- Single 2x6 joist hangers with minimum gravity capacity of 345 lbs
- Single 2x8 joist hangers with minimum gravity capacity of 490 lbs
- Single 2x10 joist hangers with minimum gravity capacity of 545 lbs
- 2x12
- Hurricane ties with minimum uplift capacity of 500 lbs
- Angle brackets
- #9 x 2.5" Hex-head exterior connector screws for hanger and bracket attachment

Spans and Spacing

- The maximum joist span recommended for 2x OC™ Lumber is found in Table 1.
- The maximum joist cantilever is 2' or ¼ of the length of the joist span, whichever length is less. The length of the cantilever is measured from the exterior side of the post or beam to the end of the rim joist (see Step 5).
- The required joist spacing recommended for 2x OC™ Lumber is found in Table 1.
- The maximum post-bearing capacity is found in Table 2 on page 6.

JOIST SIZE	SPACING (IN)	ALLOWABLE SPAN (FT)
2x6	12	8'-7"
	16	7'-9"
	24	6'-10"
2x8	12	12'-3"
	16	11'-2"
	24	9'-9"
2x10	12	14'-8"
	16	13'-4"
	24	11'-8"
2x12	12	17'-10"
	16	16'-3"
	24	14'-2"

Properties based upon test data and use nominal design dimensions (i.e., 1.5" x 5.5", 1.5" x 7.25", and 1.5" x 9.25" section properties). LL = 40 and DL = 10 PSF. Decks shall be designed for 40 PSF live load per IRC Section R301.5 or a ground snow load up to 40 PSF LL. OC™ Lumber products use proprietary materials and conditions not prescribed in IRC Section 507.1. OC™ Lumber products use design requirements, which are considered proprietary intellectual property and trade secrets,¹ pursuant to IRC Section 301.1.3, IBC Section 1706.2, IBC Section 1707.1, and IRC Section R104.11.

Note: Railings, rail posts, and stair stringers are outside the scope of this installation guide and shall be designed by others.

¹ All ideas, engineering analysis, and test data that have informed this installation guide are proprietary intellectual property (IP) and trade secrets (TS) of Owens Corning. This IP and TS will not be shared, as public regulatory officials are subject to Freedom of Information Act requests, making IP and TS provided to such officials part of the public domain when information is provided. Compliance with public records and trade secret legislation requires approval through the use of Listings, certified reports, Technical Evaluation Reports, duly authenticated reports, and/or research reports prepared by approved agencies and/or approved sources. The federal government and each state have a public records act.



STEP 1: INSTALL 2X OC™ LUMBER LEDGER

Attach ledger board to structure per building code. **Figure 1 (below):** general attachment of ledger board to band joist or rim joist.

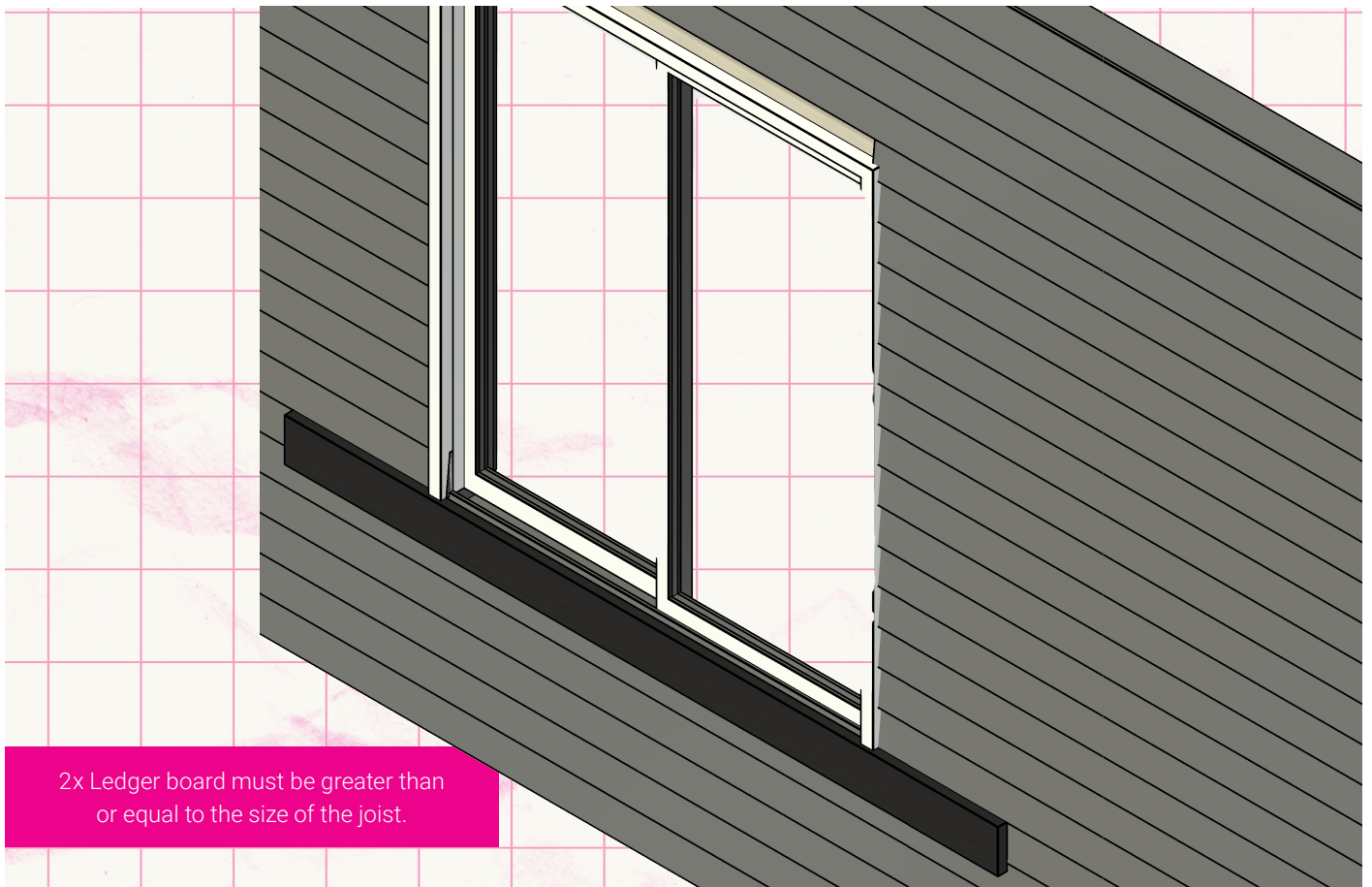
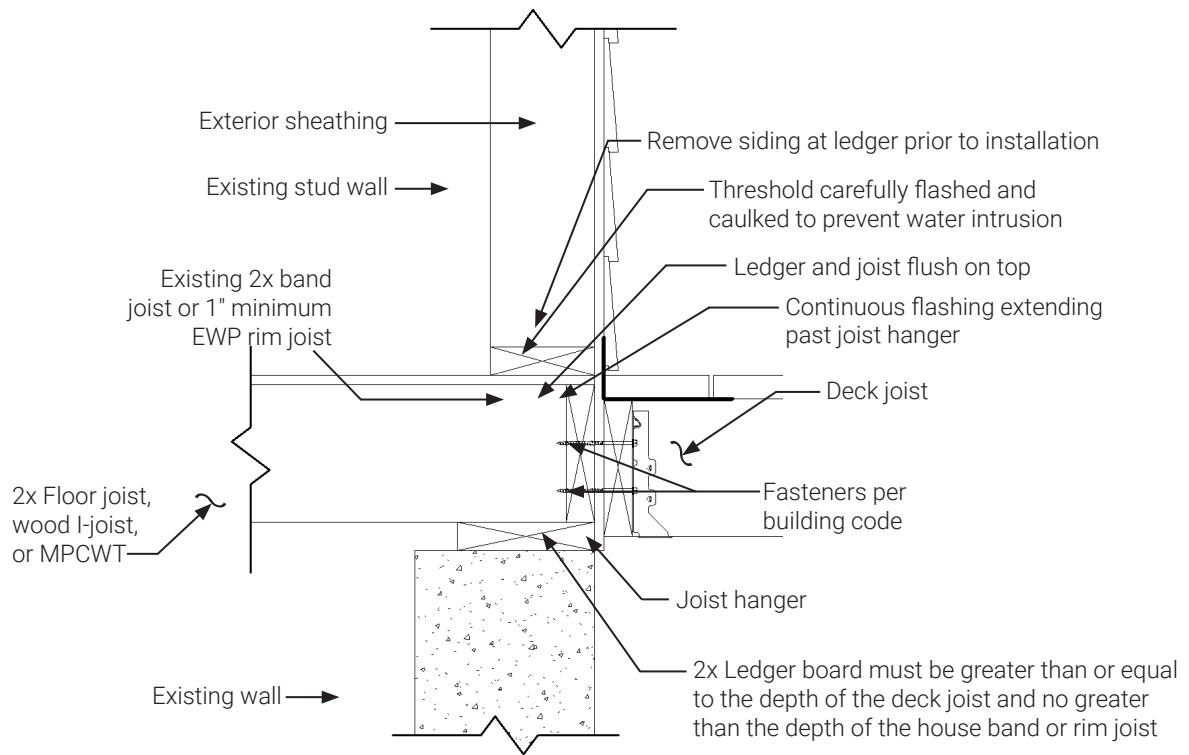

2x Ledger board must be greater than or equal to the size of the joist.

STEP 2: ASSEMBLE POSTS

Assemble 3-ply posts using 2x6 OC™ Lumber and #10 x 4" screws, 8" on center, staggered:

Figure 2: Assembly of a post to support a 2-ply beam

Figure 3: Assembly of a post to support a 3-ply beam

Table 2: Maximum post-bearing capacity when supporting 2-ply and 3-ply beams

TABLE 2: MAX. BEARING CAPACITY

TO SUPPORT A 2-PLY BEAM (FIGURE 2)	TO SUPPORT A 3-PLY BEAM (FIGURE 3)
5,500 lbs	8,250 lbs

Maximum column height is 9 ft. IMPORTANT NOTE: Column shall be diagonally braced to prevent side sway and buckling.

POST ASSEMBLY DETAILS

- ① = 3" End distance
- ② = 1.5" Edge distance
- ③ = 2.5" Spacing between rows

- = Screw from back
- = Screw from front

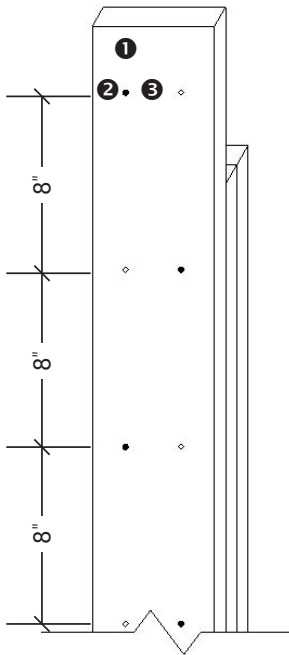

Figure 2: Post supporting a 2-ply beam

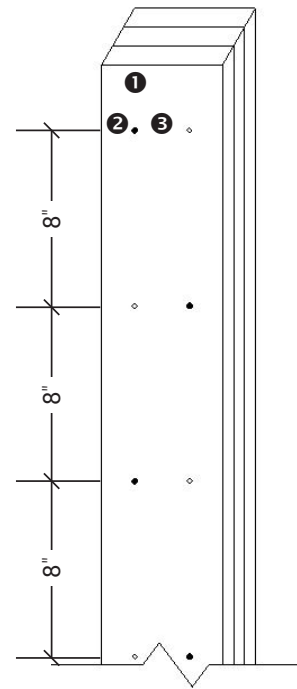
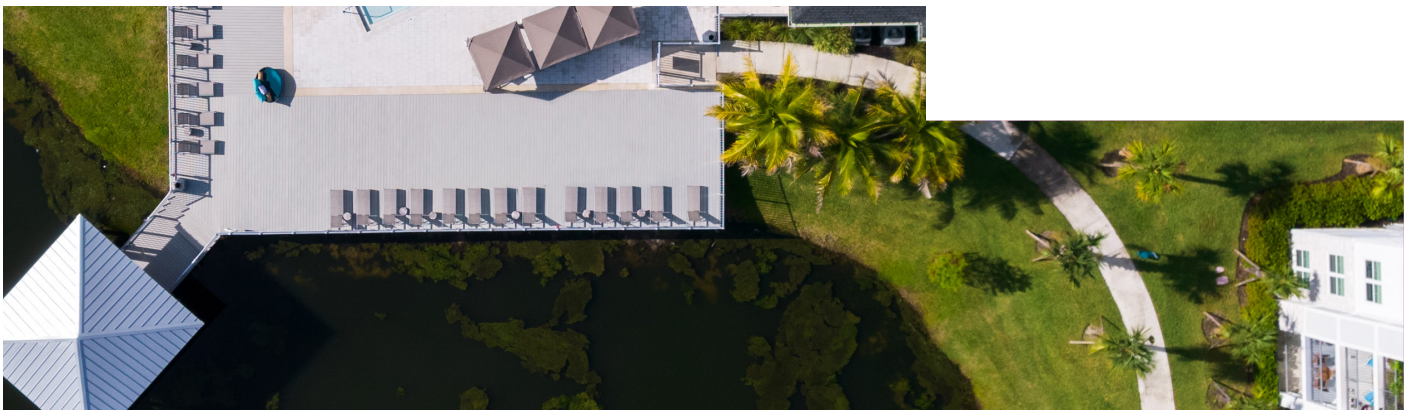

Figure 3: Post supporting 3-ply beam





STEP 3: ASSEMBLE BEAM(S)

Tables 3 and 4: Maximum post spacing recommended for 2x OC™ Lumber.

The maximum beam cantilever is 2' or ¼ of the length of the beam span between posts, whichever length is less. This length is measured from the exterior side of the post to the end of the beam.

For decks requiring support at more than 3 locations, please contact Owens Corning™ Lumber support team.

HOW TO USE TABLE 3

1. Determine the length of joist to be used for your deck (e.g., 10').
2. Find applicable "length of joist" column in Table 3 (e.g., 10').
3. Using the beam size and # of plies (e.g., 2x8 beam that is 3-ply), find the maximum OC™ Lumber post spacing (e.g., 6'-11" post spacing).
4. If applicable, add cantilever(s) to determine final beam length (e.g., if the 6'-11" post spacing has a beam with two cantilevers on each end, the maximum beam length is 10'-11").

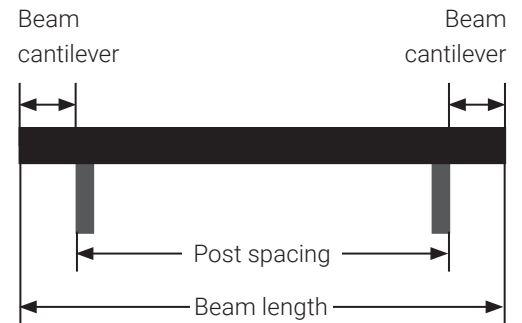

TABLE 3: MAX. POST SPACING FOR SUPPORT AT 2 LOCATIONS

BEAM SIZE	# OF PLYS	LENGTH OF JOIST (FT)							
		4'	5'	6'	7'	8'	9'	10'	11'
		POST SPACING (FT)							
2x6	2	5'-1"	4'-10"	4'-8"	4'-7"	4'-5"	4'-4"	4'-2"	4'-1"
	3	5'-10"	5'-7"	5'-5"	5'-3"	5'-1"	4'-11"	4'-10"	4'-8"
2x8	2	7'-3"	7'-0"	6'-9"	6'-6"	6'-4"	6'-2"	6'-0"	5'-10"
	3	8'-4"	8'-0"	7'-8"	7'-6"	7'-3"	7'-1"	6'-11"	6'-9"
2x10	2	8'-8"	8'-4"	8'-1"	7'-10"	7'-7"	7'-4"	7'-2"	7'-0"
	3	9'-11"	9'-7"	9'-3"	8'-11"	8'-8"	8'-5"	8'-3"	8'-1"
2x12	2	10'-7"	10'-2"	9'-10"	9'-6"	9'-3"	9'-0"	8'-9"	8'-7"
	3	12'-1"	11'-8"	11'-3"	10'-11"	10'-7"	10'-3"	10'-0"	9'-10"

LL = 40 and DL = 10 PSF. Decks shall be designed for 40 PSF live load per IRC Section R301.5 or a ground snow load up to 40 PSF LL. OC™ Lumber products use proprietary materials and conditions not prescribed in IRC Section 507.1. OC decks use design requirements, which are considered proprietary intellectual property and trade secrets, pursuant to IRC Section 301.1.3, IBC Section 1706.2, IBC Section 1707.1, and IRC Section R104.11. OC decks use proprietary materials and conditions not prescribed in IRC Section 507.1.

HOW TO USE TABLE 4

1. Determine the length of joist to be used for your deck (e.g., 10').
2. Find the applicable "length of joist" column in Table 4 (e.g., 10').
3. Using the beam size and # of plies (e.g., 2x8 beam that is 3-ply), find the maximum OC™ Lumber post spacing that supports a 10' joist (e.g., 7'-2" post spacing).
4. If applicable, add cantilever(s) to determine final beam length (e.g., if the 7'-2" post spacing has a beam with two cantilevers on each end, the max. beam length is 11'-2").

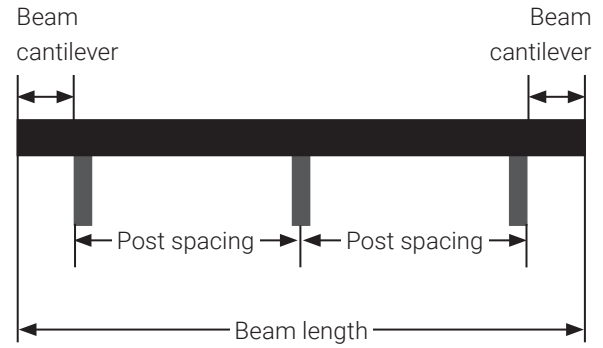

Beam must be continuous over supports.

TABLE 4: MAX. POST SPACING FOR SUPPORT AT 3 OR MORE LOCATIONS

BEAM SIZE	# OF PLYS	LENGTH OF JOIST (FT)							
		4'	5'	6'	7'	8'	9'	10'	11'
		POST SPACING (FT)							
2x6	2	5'-3"	5'-1"	4'-11"	4'-9"	4'-7"	4'-6"	4'-4"	4'-3"
	3	6'-0"	5'-10"	5'-7"	5'-5"	5'-3"	5'-1"	5'-0"	4'-11"
2x8	2	7'-6"	7'-3"	7'-0"	6'-9"	6'-7"	6'-5"	6'-3"	6'-1"
	3	8'-7"	8'-3"	8'-0"	7'-9"	7'-6"	7'-4"	7'-2"	7'-0"
2x10	2	9'-0"	8'-8"	8'-4"	8'-1"	7'-10"	7'-8"	7'-6"	7'-4"
	3	10'-4"	9'-11"	9'-7"	9'-3"	9'-0"	8'-9"	8'-7"	8'-4"
2x12	2	11'-0"	10'-7"	10'-2"	9'-10"	9'-7"	9'-4"	9'-1"	8'-11"
	3	12'-7"	12'-1"	11'-8"	11'-4"	11'-0"	10'-8"	10'-5"	10'-2"

These properties are based upon test data and use nominal design dimensions (i.e., 1.5" by 5.5", 1.5" by 7.25", and 1.5" by 9.25" section properties).

LL = 40 and DL = 10 PSF. Decks shall be designed for 40 PSF live load per IRC Section R301.5 or a ground snow load up to 40 PSF LL. OC™ Lumber products use proprietary materials and conditions not prescribed in IRC Section 507.1. OC™ Lumber products use design requirements, which are considered proprietary intellectual property and trade secrets, pursuant to IRC Section 301.1.3, IBC Section 1706.2, IBC Section 1707.1, and IRC Section R104.11. OC™ Lumber uses proprietary materials and conditions not prescribed in IRC Section 507.1.

BEAM(S) ASSEMBLY

Figure 4: Assemble 2-ply beam(s) as applicable using 2x OC™ Lumber boards and #10 x 3" stainless steel composite deck screws, staggered in 2 rows. If a splice is required, use 2 screws at each end of splice. Splices shall be located only over interior posts.

- ① = 3" End distance
- ② = 1.5" Edge distance
- ③ = 2.5" Spacing between rows
- = Screw from back
- = Screw from front

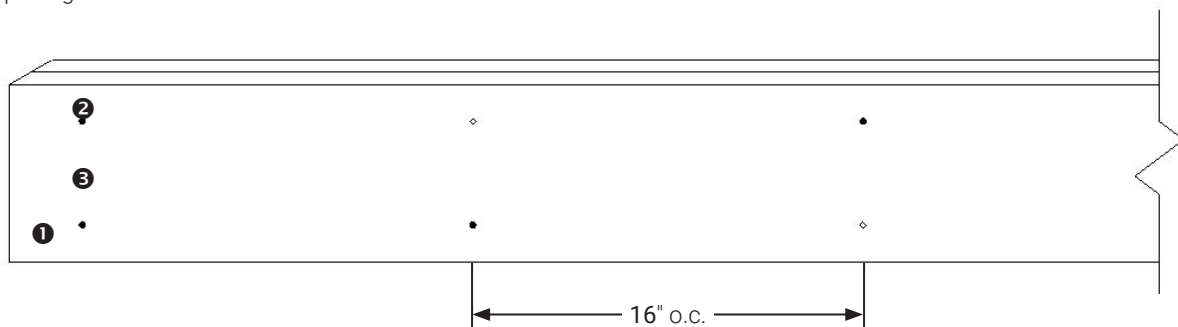
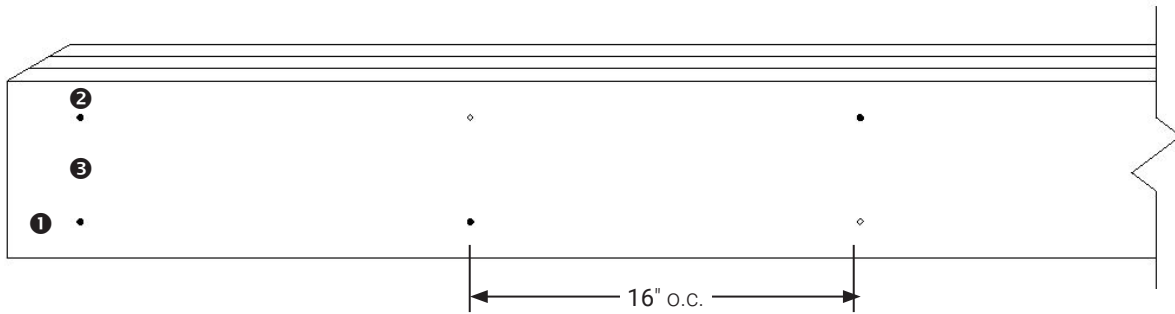

Figure 5: Assemble 3-ply beam(s) as applicable using 2x OC™ Lumber boards and #10 x 3" stainless steel composite deck screws, staggered in 2 rows. If a splice is required, use 2 screws at each end of splice. Splices shall be located only over interior posts.

- ① = 3" End distance
- ② = 1.5" Edge distance
- ③ = 2.5" Spacing between rows
- = Screw from back
- = Screw from front



STEP 4: INSTALL DROP BEAM(S) ON POSTS

Figure 6: Secure 3-ply carrying beam to each 3-ply 2x6 OC™ Lumber post using a code-compliant beam-to-post connector with minimum uplift capacity of 2,000 lbs (see next page).

Figure 7: Secure 2-ply carrying beam to each notched 3-ply 2x6 OC™ Lumber post with two rows of #10 x 3" screws per table below with minimum 1½" edge distance (see next page).

JOIST SIZE	# OF SCREWS
2x6	2
2x8	3
2x10	4
2x12	4

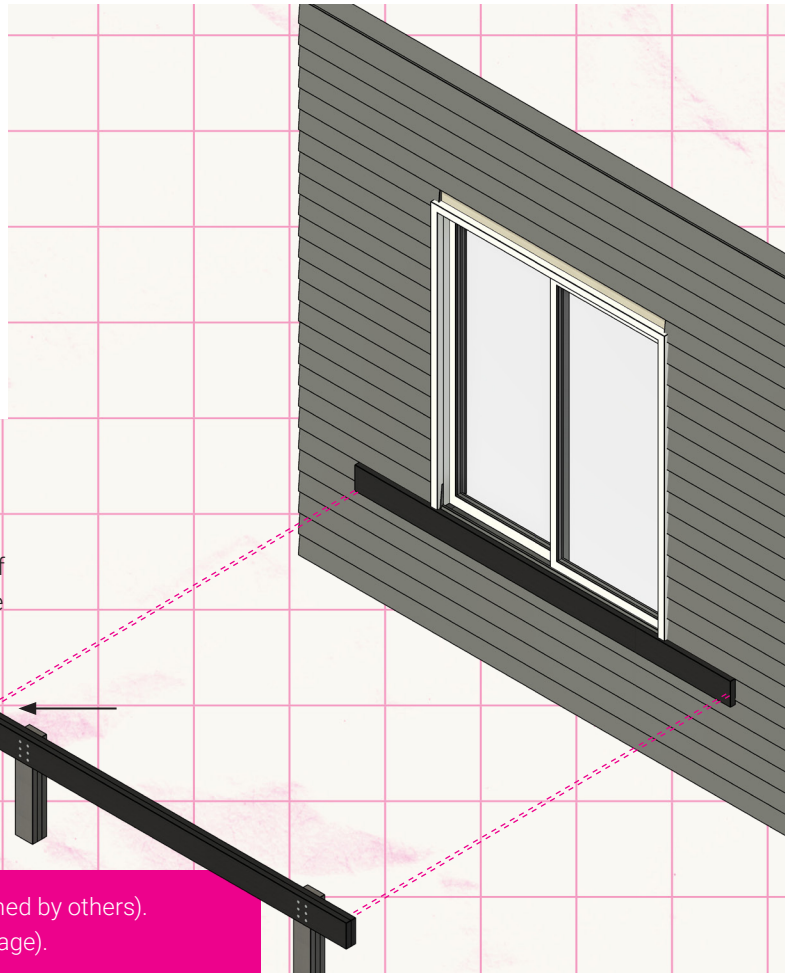

Set top of carrying beam 1½" lower than the bottom of the ledger at the house to allow for adequate drainage per building code.

Set posts on code-compliant foundation (designed by others).
See figures 8 and 9 for options (next page).

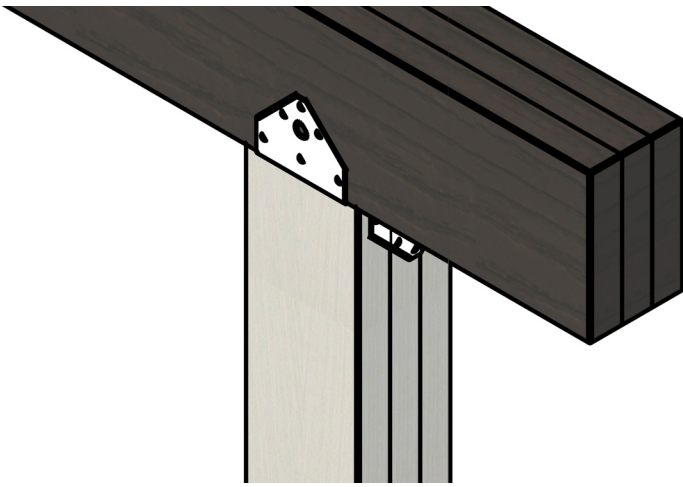

FIGURE 6: 3-Ply beam with post cap attachment

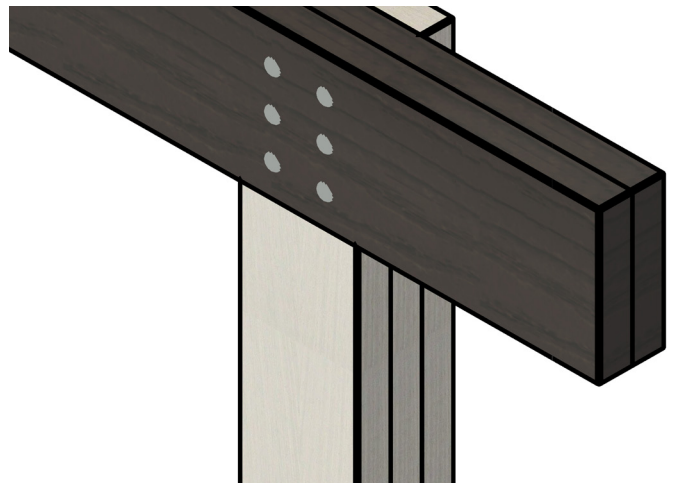

FIGURE 7: 2-Ply beam with notched post

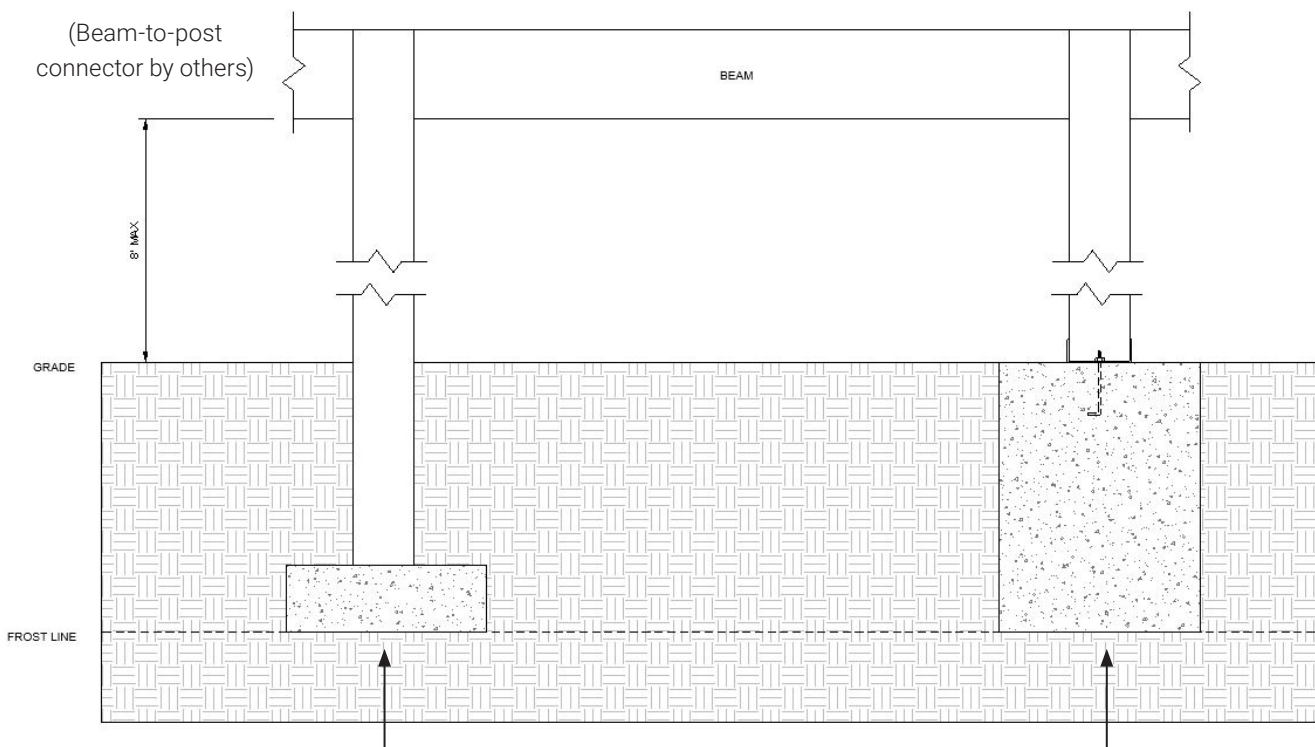
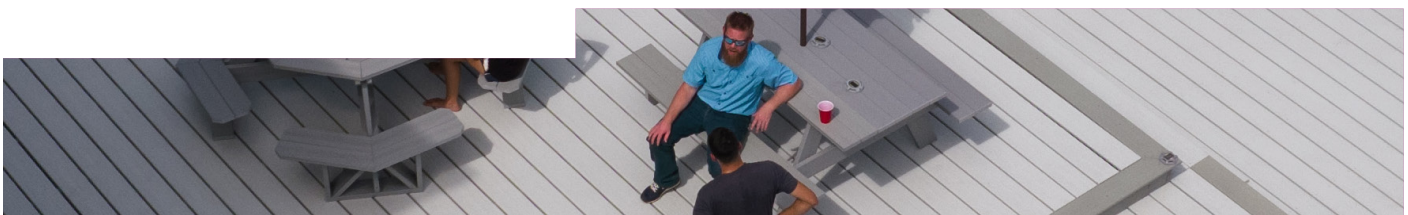

Figure 8: Post foundation backfilled with dirt or concrete

Figure 9: Post foundation mounted on concrete pad using above-ground connector with minimum uplift capacity of 2,000 lbs

Note: Code-compliant foundation options are designed by others and assume maximum 8' free span of height.



STEP 5: INSTALL OC™ LUMBER JOISTS

- Install OC™ Lumber 2x double band joist using a double 2x joist hanger with a minimum gravity capacity as outlined on page 4.
- Secure the joists together with two rows of #10 x 3" stainless steel composite deck screws staggered 12" on center.
- Install subsequent single 2x joists at applicable on-center spacing found in Table 1 using a single 2x joist hanger with a minimum gravity capacity as outlined on page 2.
- Hanger attachment per manufacturer instructions using #9 2.5" hex-head exterior connector screws. Note: Not designed for bracket use with smooth-shank or nail fasteners.
- Complete joist installation with a 2x double joist at opposite edge of ledger.
- Secure each joist to the drop beam using a hurricane tie with a minimum uplift capacity of 500 lbs.

Repeat Step 5 until all joists are installed, ending with a double joist.

TABLE 1: MAX. ALLOWED JOIST SPANS

JOIST SIZE	SPACING (IN)	ALLOWABLE SPAN (FT)
2x6	12	8'-7"
	16	7'-9"
	24	6'-10"
2x8	12	12'-3"
	16	11'-2"
	24	9'-9"
2x10	12	14'-8"
	16	13'-4"
	24	11'-8"
2x12	12	17'-10"
	16	16'-3"
	24	14'-2"

Properties based upon test data and use nominal design dimensions (i.e., 1.5" x 5.5", 1.5" x 7.25", and 1.5" x 9.25" section properties).
 LL = 40 and DL = 10 PSF. Decks shall be designed for 40 PSF live load per [IRC Section R301.5](#) or a ground snow load up to 40 PSF LL. OC™ Lumber products use proprietary materials and conditions not prescribed in [IRC Section 5071](#). OC™ Lumber products use design requirements, which are considered proprietary intellectual property and trade secrets,¹ pursuant to [IRC Section 301.1.3](#), [IBC Section 1706.2](#), [IBC Section 1707.1](#), and [IRC Section R104.11](#).

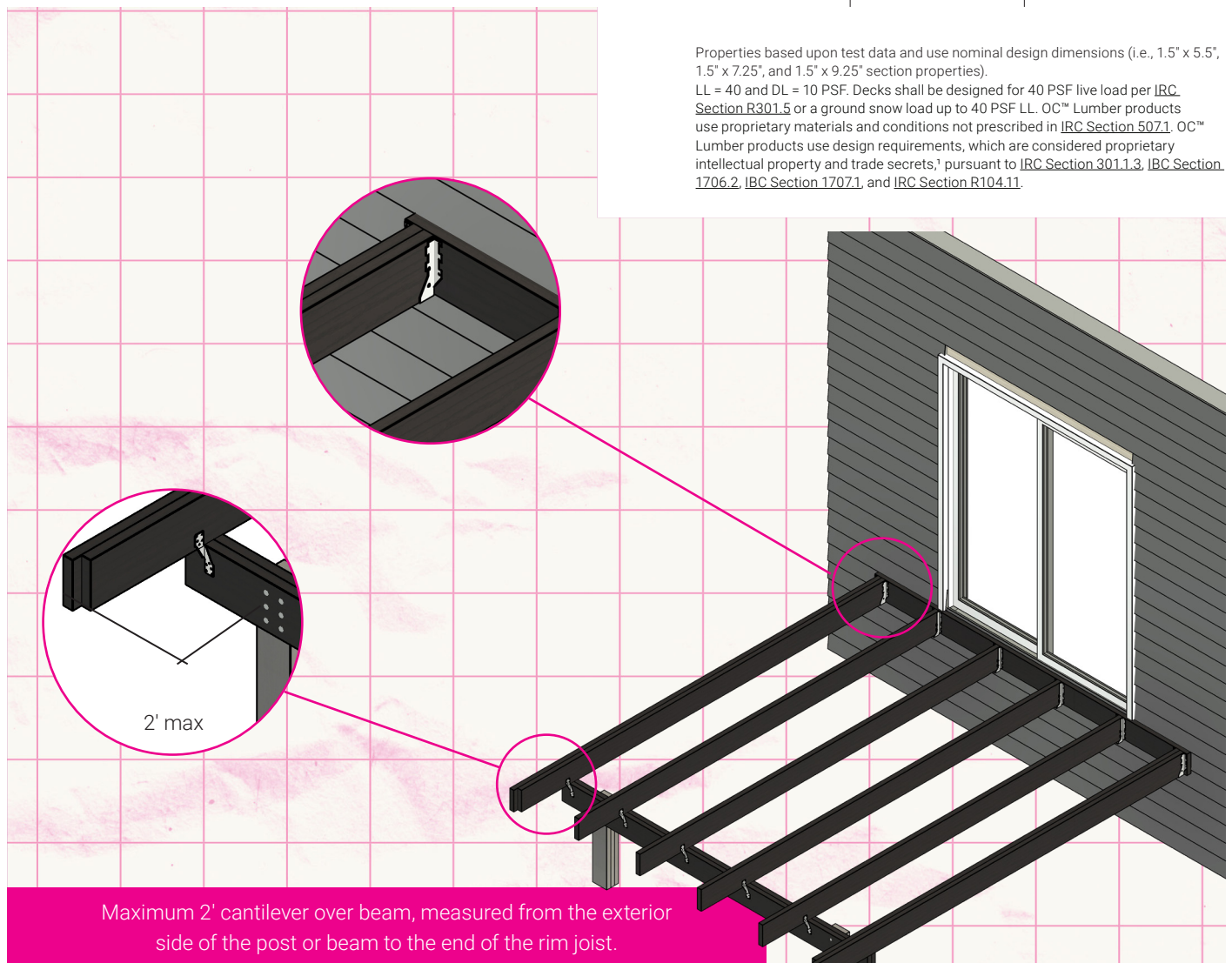

Maximum 2' cantilever over beam, measured from the exterior side of the post or beam to the end of the rim joist.

STEP 6: ADD MID-SPAN & BEARING BLOCKING

Install 2x blocking between each joist at 4'-5' spacing between the ledger board and the drop beam. Similar blocking is also recommended over the drop beam. Stagger block as shown to allow the use of two equally spaced #10 x 3" coated deck screws, with a 1½" edge distance through the side of the joist into the centerline of each block.

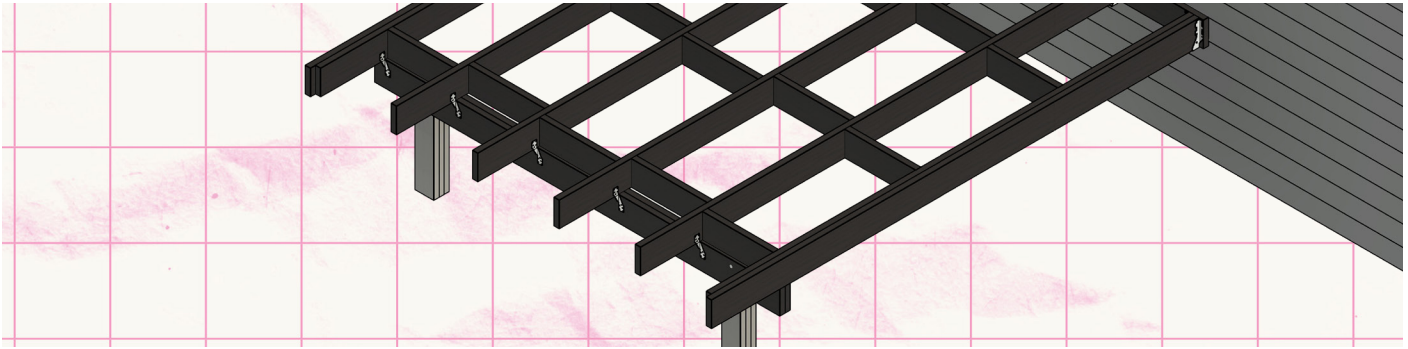

STEP 7: ATTACH FRONT RIM JOIST

Attach first front rim joist at all joist locations through the side of the rim board into the centerline of each joist using a #10 x 3" screw per table below with a minimum 1½" edge distance.

Install second rim board, securing the rim boards together with two rows of #10 x 3" screws staggered 12" on center with a minimum 1½" edge distance. Secure second rim board at corners with required number of screws per table below, passing from the face of one board centered into the end of the adjoining board.

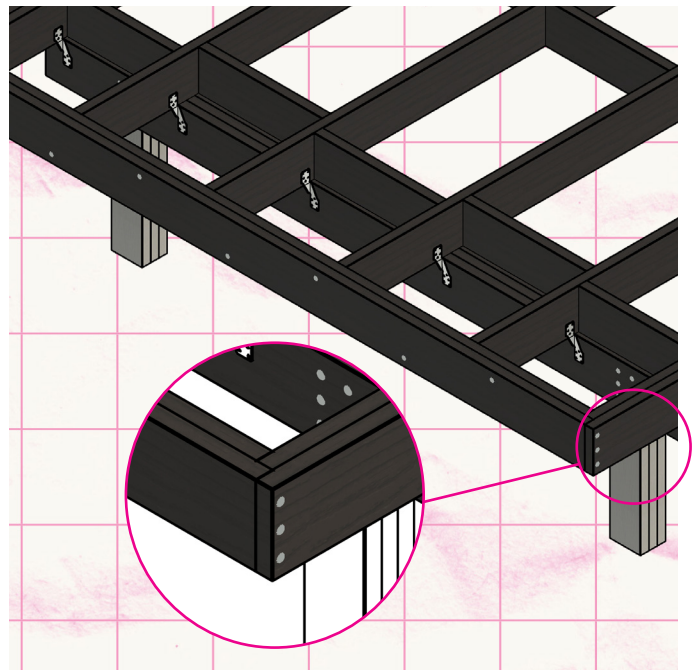
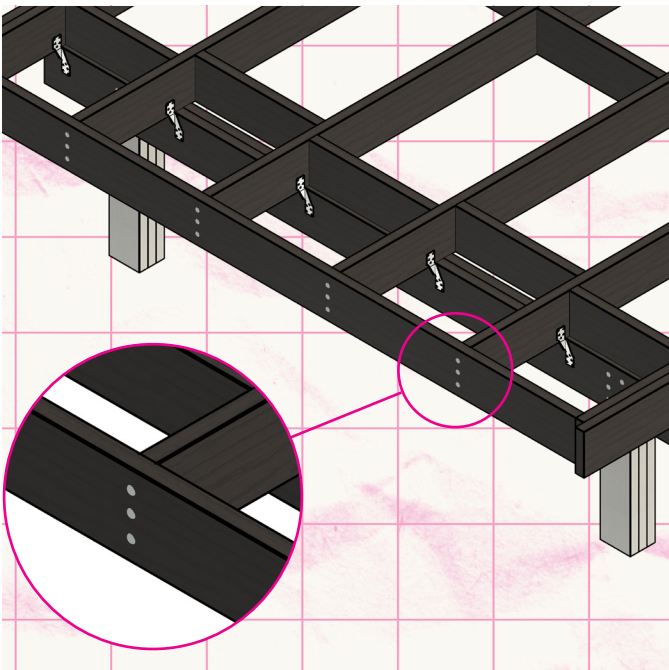

JOIST SIZE	# OF SCREWS
2x6	2
2x8	3
2x10	4
2x12	4

STEP 8: INSTALL DECK BOARDS

Install deck boards perpendicular to the joists with a recommended end-to-end and side-to-side spacing of 3/16" between each board (1/16" minimum spacing). Secure each board to all joists using two #9 x 2.5" composite deck screws. Overhangs up to 2" from each side are acceptable.

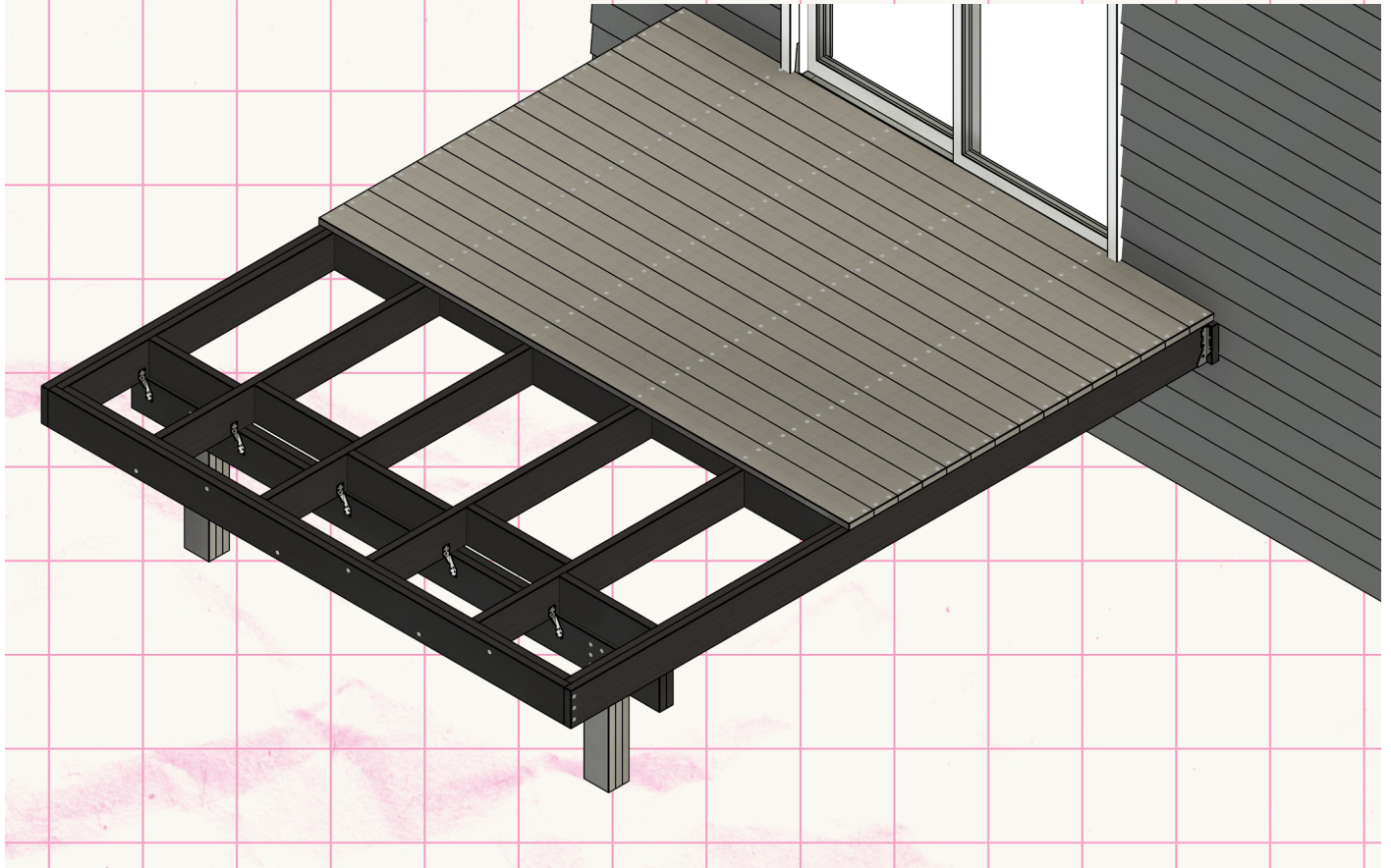

SUSTAINABILITY **IT ALL ADDS UP TO MAKE A DIFFERENCE**

Owens Corning® Lumber helps you build deck structures that will last, reducing the amount of deck framing boards that will end up in the landfill.

OUR 2030 GOALS



Reduce Greenhouse Gas Emissions by half.



Switch to 100% Renewable Electricity.



Send Zero Waste to Landfill by cutting the amount of waste we generate in half and recycling the rest.



HOW WE BUILD NOW™

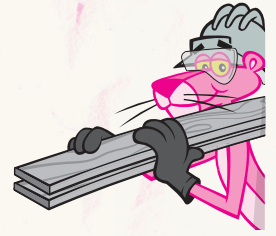

LEARN MORE AT [OWENSCORNING.COM/LUMBER](https://www.owenscorning.com/lumber)



[OwensCorningLumber](https://www.facebook.com/OwensCorningLumber)



[oc.lumber](https://www.instagram.com/oc.lumber)



[oc.lumber](https://www.tiktok.com/oc.lumber)



HOW WE BUILD NOW™

Owens Corning Lumber

5111 S. Pine Ave. #G
Ocala, FL 34480 USA
855.909.9501

<https://www.owenscorning.com/framing>

This information and data contained herein is offered solely as a guide in the selection of product. We believe this information to be reliable but do not guarantee its applicability to the user's process or assume any responsibility or liability arising out of its use or performance. The user agrees to be responsible for thoroughly testing any application of the product to determine its suitability. Statements in this publication shall not be construed as representations or warranties or as inducements to infringe on any patent or violate any law, safety code, or insurance regulation. We reserve the right to modify this document without prior notice.

Pub. No. 10026715-B. August 2024. THE PINK PANTHER™ & © 1964-2024 Metro-Goldwyn-Mayer Studios Inc. All Rights Reserved. © 2024 Owens Corning. All Rights Reserved.