



PERIMETER FIRE CONTAINMENT SYSTEM GUIDE

Life Safety Components and Systems
Codes and Compliance



TABLE OF CONTENTS

- Introduction.....3**
- A Brief History of Perimeter Fire Containment4**
- Life Safety.....6**
- Fire Testing Standards.....7**
 - ASTM E119.....7
 - ASTM E2307.....8
 - ASTM E28749
- International Building Codes and Compliance.....10**
- Critical Components of a Listed Perimeter Fire Containment Assembly12**
 - Aluminum-Framed Curtain Wall System12
 - Steel-Framed Curtain Wall System14
- Our Most Common Perimeter Fire Containment Systems16**
- Smoke Sealants.....19**
- Spandrel Requirements20**
- Special Conditions.....21**
 - Short or Zero Spandrel Conditions.....21
 - Wide Spandrel Conditions.....21
 - Steel Back Pans22
 - Curved Spandrel Walls.....24
 - Angled Spandrel Walls24
 - Exposed Curtain Wall Anchors at the Floor Line.....25
- Combustible Building Materials Used in Perimeter Fire Containment Systems.....25**
 - NFPA 285.....26
- Engineering Judgments.....27**
- Pioneers in Improving Building Safety28**
- Project Spotlight.....29**

PERIMETER FIRE CONTAINMENT SYSTEMS:

A Component of Life Safety, Designed Property Protection Through Innovation and Science

Each year in the U.S., fire is responsible for about 3,000 deaths and over \$12 billion in property loss.¹ In non-residential buildings alone, losses in 2019 were nearly \$3 billion.²

While these statistics are sobering, fire losses – both in life and property – have been decreasing over the past decade,³ thanks in part to better fire containment strategies.

Even when lives are spared, fire losses can be devastating. A proper fire containment system helps save buildings, intellectual property, and business capital, along with allowing the people inside the structure more time to escape in the event of a fire.

Thermafiber, Inc. is the pioneer of today's perimeter fire containment systems using mineral wool insulation.⁴

Today, Thermafiber is committed to helping architects and builders improve the safety of their structures. We've prepared this guide to fire containment standards and installation, for easy-to-reference information to help maximize the fire safety of your next project.

Thermafiber Insolutions®

The Thermafiber Insolutions® team provides perimeter fire containment solutions to fit the unique design needs of today's innovative commercial buildings. This five-step approach saves time and budget on projects, while delivering outstanding performance that meets demanding building standards.

Our 5-pronged approach to improving building safety⁵

- **1 All-phase consultation and technical expertise**

Engineering judgments, accurate and detailed CAD drawings, and a knowledge base of building codes and insulation application techniques focused on perimeter fire containment solutions without sacrificing design. We are the only mineral wool manufacturer that develops engineering judgments on PFC systems and is uniquely suited to evaluate conditions where NFPA 285 is a consideration.
- **2 High-performing products and systems**

Thermafiber® FireSpan® and Thermafiber® Safing products have been extensively evaluated per ASTM E2307 to provide a barrier to fire and hot gases at temperatures above 2,000°F (1,093°C) in tested and listed perimeter fire containment systems with UL® and Intertek®.
- **3 Cost-saving insulation hanger systems**

Patented Thermafiber® Impasse® Hangers lock the perimeter fire containment system in place for faster, more accurate, and safe insulation positioning with less hangers needed than traditional installation methods and less costly components in the PFC system.
- **4 Labor-saving systems**

Patented Thermafiber® Impasse® Perimeter Fire Containment Systems using Thermafiber® Impasse® Hangers streamline the installation of curtain wall insulation by changing the order of traditional installation steps to fit a more logical progression.
- **5 Contributing to green building credits**

Thermafiber® mineral wool insulation that helps earn your building LEED® and other green building program credits with a minimum of 70% recycled content, and available in formaldehyde-free formulations.

A BRIEF HISTORY OF PERIMETER FIRE CONTAINMENT

Architects and curtain wall designers have long recognized that the void created between the floor slab and exterior wall, if left unprotected, would allow fire and smoke to propagate to the floor above. The logical fix seemed to be to fill the void with fire-resistant material. However, if the void is simply filled with mineral wool and a portion of the spandrel area is left unprotected, the curtain wall will fail, causing the mineral wool to fall out of the void. Once the mineral wool at the joint is lost, fire will propagate through the opening, allowing fire to engage combustibles in the floor above. This effect was demonstrated in a 1999 study by the Loss Prevention Council in the UK.

While the UK was drawing its conclusions, Thermafiber, Inc. was also conducting fire testing. In fact, Thermafiber, Inc. pioneered the perimeter fire containment system and helped Underwriters Laboratories (UL®) develop a test standard so that these systems could be evaluated by their lab and listed in their fire resistance directory. The first UL® tested and listed assembly was conducted in 1997.

As the cross-section drawing illustrates, a test in 1999 by the Loss Prevention Council in the United Kingdom installed mineral wool between the glass and face of the floor slab (Fig. 1).

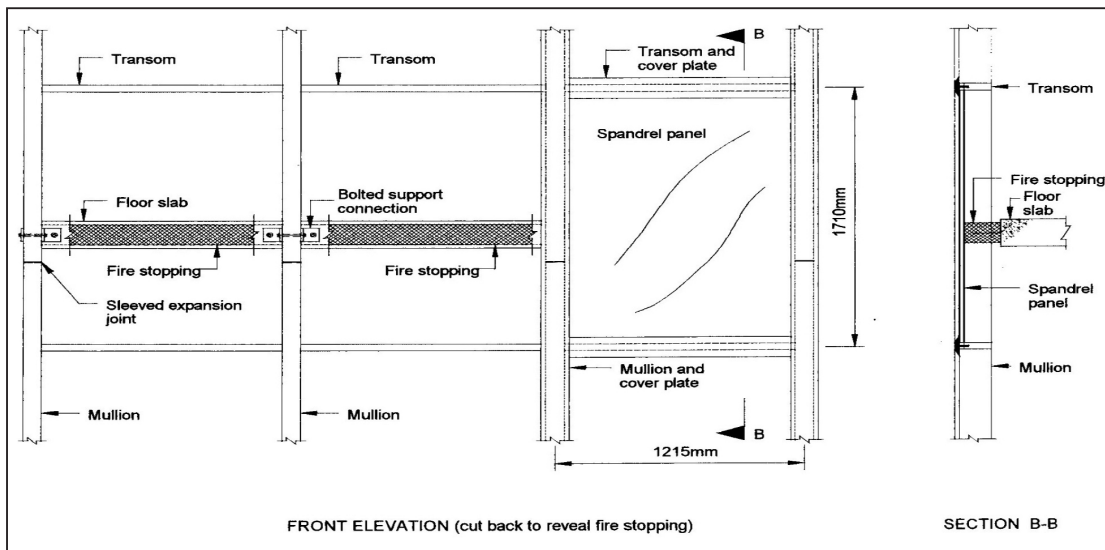

Fig.1 – Typical curtain wall system panel

Within the first 10 minutes of the fire, the glass broke out and the safin fell out of the void, allowing fire to propagate to the next floor. In-depth testing conducted in collaboration between Thermafiber, Inc. and Underwriters Laboratories (UL®) led to the development of a test standard that ultimately became ASTM E2307, the test standard for evaluating perimeter fire containment systems (Fig. 2).

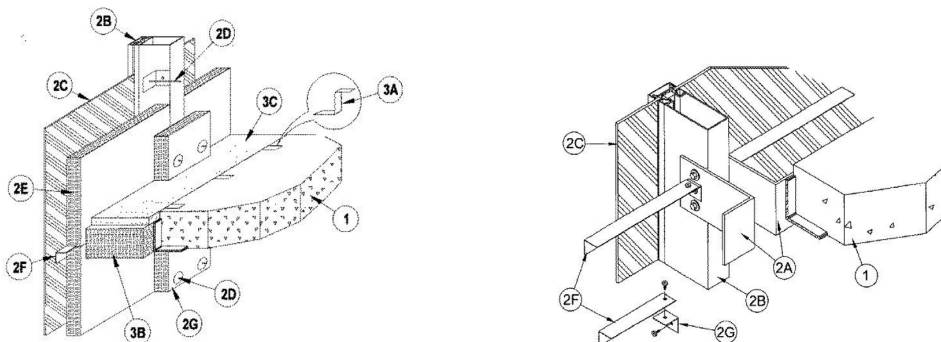

Fig. 2 UL's First Published Curtain Wall Assembly: CW-S-2001 Issued: 4/14/97

Following more than 20 years of various code requirements for the floor-to-floor fire containment in the curtain wall condition, ASTM E2307 was published as the definitive test method for evaluating the performance of perimeter fire containment assemblies and quickly adopted into the 2006 edition of the International Building Code (IBC).

Paths of Fire Propagation

There are two paths of fire propagation:

1. Fire can spread through the interior joint between the rated floor assembly and unrated curtain wall.
2. Fire can also propagate via the exterior of the building, an effect known as "leap frog," in conditions where there is zero, or very short, spandrel protection. Leap frog fire spread occurs when the fire breaks out the vision glass on the floor where the fire originated, allowing flame and hot gases to escape to the outside of the building. The fire then breaks out the vision glass on the floor above and enters into the interior space, engaging combustibles and continuing to cause fire spread vertically, via the exterior of the building. Fire can also spread via the interior cavity of an unprotected or improperly protected spandrel area.

Vertical fire spread in an unprotected curtain wall



This illustration shows how fire can spread vertically when a curtain wall is left unprotected.



This photo shows the results of "leap frog" fire propagation. Note how the fire has spread vertically along the outside of the high rise.

Vertical fire spread when curtain wall is protected by a mineral wool perimeter fire containment system



Here, both the curtain wall spandrel and interior joint are protected by a mineral wool perimeter fire containment system, preventing the spread of fire.

LIFE SAFETY

The Balanced Approach to Life Safety

There are three elements to address life safety that are used by the building community and required by code:

- 1 Detection**
- 2 Suppression** (active systems)
- 3 Compartmentation** (passive systems)

We've learned from history not to rely solely on any one of these elements in our buildings, but to include all three. This is known as the balanced approach to life safety. These three elements are required to increase the probability of successfully maximizing life safety in high-rise buildings. Life safety can be defined as the preservation of human life in the event of a catastrophic event, such as a fire.

Balancing the Three Elements of Life Safety

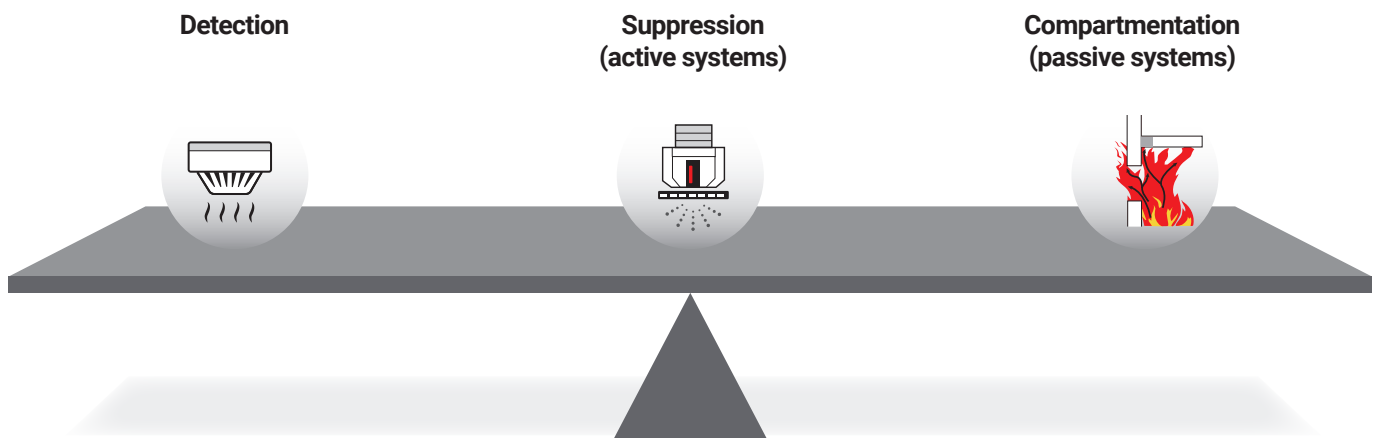

- 1**
 - Detection includes alarm systems, such as smoke and heat detectors, that notify the occupants that there is a safety hazard.
- 2**
 - Installation of sprinkler systems is the most common method of suppression.
 - A system is considered "active" if it requires some form of activation to switch the system to the "on" position.
 - The system must turn on in order for it to work.
- 3**
 - Once installed, passive systems do not require activation for operation.
 - If properly installed, passive systems will work.
 - Passive systems, such as a perimeter fire containment system, contain the fire to the room of origin, allowing occupants time to evacuate the building and allowing fire personnel time to enter the building to extinguish the fire.

Elements That Contribute to Life Safety in High-Rise Construction:

1. Fire containment utilizing fire-rated construction to minimize occupant exposure to fire and smoke
2. Ability to suppress and limit fire spread
3. Helping to maintain structural integrity of the building during a fire
4. Incorporating all three elements for added safety layers. If one element fails, there is a backup plan in place.

FIRE TESTING STANDARDS FOR EVALUATING PERFORMANCE OF COMMON BUILDING MATERIALS WHEN EXPOSED TO A COMMERCIAL FIRE

ASTM E119⁶

In this test method, various types of building elements are exposed to fire for a predetermined time to measure which materials contain a fire and/or retain their structural integrity. The test exposes a material to a standard controlled fire to achieve specified temperatures throughout a specified time period. This follows a curve known as the ASTM E119 Time-Temperature Curve, seen below.

ASTM E119 is an important test for evaluating building elements. However, ASTM E119 only tests fire exposure on one side of the assembly. For perimeter fire containment systems, the correct ASTM standard to reference is ASTM E2307. See International Building Code on page 10 (715.4 explanation) for more details.

This illustrates why mineral wool is utilized in perimeter fire containment systems as it is the only material tested and proven to perform at temperatures above 2,000°F (1,093°C) after five hours of fire exposure.

ASTM E119 Time Temperature Curve

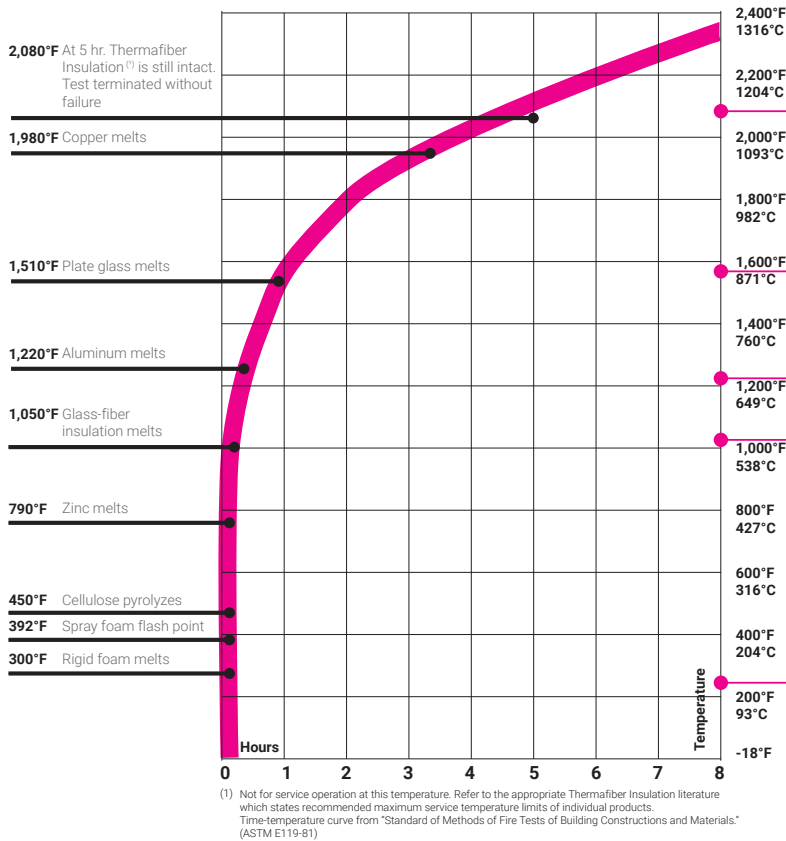

At 5 hours and temperatures of 2,080°F, mineral wool insulation remains fully intact.

After 25 minutes, test temperatures reach 1,510°F, melting plate glass.

Temperatures reach 1,220°F at 9 minutes. Aluminum framing and curtain wall anchors begin to melt.

6 minutes into the test, temperatures reach 1,050°F, melting any type of spray foam, zinc, and glass fiber insulation.

Exposure at the beginning of the test takes place quickly, with temperatures growing very rapidly, as the red line shows. This quick temperature rise is typical of a real fire condition.



After five hours, the test was terminated, with mineral wool insulation still fully intact. No other building element outlasts mineral wool insulation in these simulated fire conditions, making it the ideal choice for fire containment assemblies.

FIRE TESTING STANDARDS FOR EVALUATING FIRE PERFORMANCE OF PERIMETER FIRE CONTAINMENT SYSTEMS

ASTM E2307⁷

ASTM E2307 measures the ability of perimeter fire containment systems to maintain a barrier and helps prevent interior fire spread as the exterior wall assembly deflects/deforms during fire exposure. ASTM E2307 determines the period of time that the perimeter fire containment system will limit flame penetration through the opening between the exterior wall assembly and the floor assembly.

The ASTM E2307 test exposes the joint to fire from the room of fire origin. The exterior wall is also exposed to fire from both the interior and exterior, as the fire plume exits the room of origin through a window opening.

After the first 30 minutes of the test, the ASTM E2307 test essentially parallels the ASTM E119 time-temperature in the test room for the remainder of the test. However, perimeter fire containment systems must be compliant to ASTM E2307 to effectively provide a barrier to flame and hot gases at the perimeter joint.

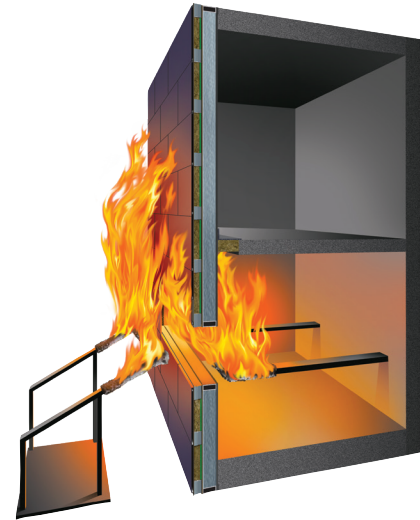

These are photos of an actual test per ASTM E2307:



View of the assembly as the fire begins with ignition of the room burner.



Approximately five minutes into the fire, to simulate vision glass breakage, the window burner is ignited.

The aftermath of the fire shows the destruction caused by the flame and hot gases. Note the loss of the vertical and horizontal framing members.



FIRE TESTING STANDARDS FOR EVALUATING FIRE PERFORMANCE OF PERIMETER FIRE CONTAINMENT SYSTEMS

ASTM E2874

Standard Test Method for Determining the Fire-Test Response Characteristics of a Building Spandrel-Panel Assembly Due to External Spread of Fire

This test method was developed by ASTM Subcommittee E05.11 and was recently introduced. This new test method provides for measurements and evaluations as outlined below:

- The ability of the spandrel-panel assembly to resist the passage of flames or hot gases sufficient to ignite a cotton pad or be visible to an observer.
- Transmission of heat through, and above, the spandrel-panel assembly using heat flux and unexposed surface temperature measurements.
- The testing method's "scope" section describes new standard to evaluate the fire-test response of a spandrel-panel assembly spanning the intersection of a floor assembly. The testing method assesses the spandrel-panel assembly's ability to impede the spread of fire to a room's interior or the floor immediately above it via fire spread from the exterior of a building. ASTM E2874-19 evaluates areas of the exterior wall between vertically adjacent window openings in multi-story buildings and addresses the potential for fire spread to a floor above the room of fire origin. The testing method simulates a fire in a post-flashover condition in a compartment vented to the exterior via a window opening. This testing method does not provide quantitative information about the spandrel-panel assembly's performance relative to smoke or gas leakage. Nor does it evaluate the fire-test response characteristics of perimeter joint protection between the floor assembly and the building assembly's exterior wall, which is evaluated by test method ASTM E2307.
- ASTM E2874 is currently not a code requirement; however, perimeter fire containment assemblies tested to this standard, along with ASTM E2307, provide a design option for buildings seeking a total perimeter fire containment system.

INTERNATIONAL BUILDING CODES AND COMPLIANCE

There are several sections of the code that relate to the protection of the exterior curtain wall condition. It is easy to misunderstand which code section to follow as it pertains to code-compliant perimeter fire containment systems.

International Building Codes 2021

Section 705.8.5 Vertical Separation of Openings

Openings in exterior walls in adjacent stories **shall be separated vertically** to help protect against fire spread on the exterior of the buildings where the openings are within 5 feet (1524 mm) of each other horizontally and the opening in the lower story is not a protected opening with a fire protection rating of not less than $\frac{3}{4}$ hour. Such openings shall be separated vertically **not less than 3 feet** (914 mm) by spandrel girders, exterior walls, or other similar assemblies that have a fire-resistance rating of not less than 1 hour, rated for exposure to fire from both sides, or by flame barriers that extend horizontally not less than 30 inches (762 mm) beyond the exterior wall. Flame barriers shall have a fire-resistance rating of not less than 1 hour. The unexposed surface temperature limitations specified in ASTM E119 or UL263 shall not apply to the flame barriers unless otherwise required by the provisions of this code.

Exceptions:

1. This section shall not apply to buildings that are three stories or less above grade plane.
2. This section shall not apply to buildings equipped throughout with an automatic sprinkler system in accordance with section 903.3.1.1 or 903.3.1.2.
3. Open parking garages.

Explanation of Section 705.8.5

Section 705.8.5 references the rated 3-foot spandrel requirement. However, it allows for this section to be disregarded when one of the three above exceptions are met. Most often, Exception 2 is applicable to tall structures, as most are equipped throughout with automatic sprinkler systems. Therefore, it is often misunderstood, that if a project meets Exception 2, designing and installing a perimeter fire containment system is not required, or that installing safing only in the interior joint opening will suffice. This is simply not true. Section 715.4 clearly states that a perimeter fire containment system must be incorporated when a fire-resistance-rated floor assembly intersects with a non-fire-rated exterior curtain wall.

Section 715.4 Exterior Curtain Wall/Fire-Resistance-Rated Floor Intersections

Voids created at the intersection of exterior curtain wall assemblies and fire-resistance-rated floor or floor/ceiling assemblies **shall be protected with an approved perimeter fire containment system to prevent the interior spread of fire.** Such systems shall provide an **F rating for a time period not less than the fire-resistance rating of the floor or floor/ceiling assembly.**

Section 715.4.1 Fire Test Criteria

Perimeter fire containment systems shall be tested in accordance with the requirements of ASTM E2307.

ASTM E119 Exception:

Voids created at the intersection of the exterior curtain wall assemblies and floor assemblies where the vision glass extends to the finished floor level shall be permitted to be protected with an approved material to prevent the interior spread of fire. Such material shall be securely installed and capable of preventing the passage of flame spread and hot gases sufficient to ignite cotton waste where subjected to ASTM E119 time-temperature fire conditions under a minimum positive pressure differential of 0.01 inch (0.254 mm) of water column (2.5 Pa) for the time period not less than the fire-resistance rating of the floor assembly.

Explanation of Section 715.4

Section 715.4 states that the void created between the slab edge and the curtain wall must be protected with a perimeter fire containment system tested per ASTM E2307 that provides an F rating of not less than the fire-resistance rating of the floor assembly.

The exception in the 2021 code for assemblies with vision glass extending to the finished floor level permits the safe-off void to be protected with an approved material to prevent the interior spread of fire. According to the exception, the material must be tested to ASTM E119 to show it is capable of staying in place and not allowing fire to spread through the safe-off area. This exception was adopted in the code during the time when there were no available ASTM E2307-tested designs with vision glass to top-of-floor slab systems or with very short or zero spandrel conditions.

Today, there are several tested and listed systems that satisfy this condition; for example, TFI/BPF 180-07 (reference page 16 for more information). Thermafiber, Inc. recommends utilizing systems tested to ASTM E2307 since it is difficult to evaluate exterior curtain wall conditions to the ASTM E119 test methodology and to provide the maximum level of protection for building occupants. It should also be noted that there is no reference in this section of the code, or any other sections, that allows the requirements of 715.4 to be omitted. Section 715.4 addresses protection against interior fire spread only. Leap frog, the condition where fire spreads via the exterior of the building, is currently not addressed by the codes.

Section 715.5 Exterior Curtain Wall/NonFire-Resistance-Rated Floor Assembly Intersections

Voids created at the intersection of exterior curtain wall assemblies and nonfire-resistance-rated floor or floor/ceiling assemblies shall be filled with an approved material or system to retard the interior spread of fire and hot gases between stories.

Explanation of Section 715.5

It was recognized that conditions where an interior joint occurred between a nonrated exterior curtain wall assembly and nonfire-resistance-rated floor assembly that protection was needed in this area as well. Although such joints are often small (2 to 3 inches wide), consider then, for a building with a footprint of 200 feet x 200 feet (800 lineal feet), an unprotected joint of a 3-inch size creates 200 square feet of open area along the perimeter that will allow for smoke and hot gases to flow freely from floor to floor.

Section 715.6 Exterior Curtain Wall/Vertical Fire Barrier Intersections

Voids created at the intersection of nonfire-resistance-rated exterior curtain wall assemblies and vertical fire barriers shall be filled with an approved material or system to retard the interior spread of fire and hot gases.

Section 715.7 Curtain Wall Spandrels

Height and fire-resistance requirements for curtain wall spandrels shall comply with Section 705.8.5. Where Section 705.8.5 does not require fire-resistance-rated curtain wall spandrels, the requirements of Sections 715.4 and 715.5 shall still apply to the intersection between the curtain wall spandrels and the floor.

Section 715.8 Joints and Voids in Smoke Barriers

Fire-resistant joint systems protecting joints in smoke barriers, and perimeter fire containment systems protecting voids at the intersection of a horizontal smoke barrier and an exterior curtain wall, shall be tested in accordance with the requirements of UL 2079 for air leakage. The L rating of the joint system shall not exceed 5 cubic feet per minute per linear foot (0.00775 m³/s m) of joint at 0.30 inch (74.7 Pa) of water for both the ambient temperature and elevated temperature tests.

2020 Edition of Canadian National Building Code

3.1.8.3, General Requirement

Any wall, partition or floor assembly required to be a fire separation shall:

- a)... be constructed as a continuous element
- b)... have a fire resistance rating when specified
- c)... have openings protected with closures

Currently, the National Building Code of Canada does not address the issue of firestopping perimeter joint systems between a rated floor assembly and a nonrated exterior wall. The only thing that really addresses the joint is stated in the general continuity language for the requirement of the integrity of fire separation to be maintained at the perimeter joint. **There have been changes to CAN/ULC-S115 with the edition of Section 9 on Perimeter Joint Firestop Systems, and this section now states that perimeter joint firestop systems must be tested to ASTM E2307.**

SIX CRITICAL COMPONENTS OF A LISTED ALUMINUM-FRAMED PERIMETER FIRE CONTAINMENT ASSEMBLY

For a perimeter fire containment assembly to work properly and meet code requirements, certain critical design elements must be included.

Aluminum-Framed Curtain Wall System

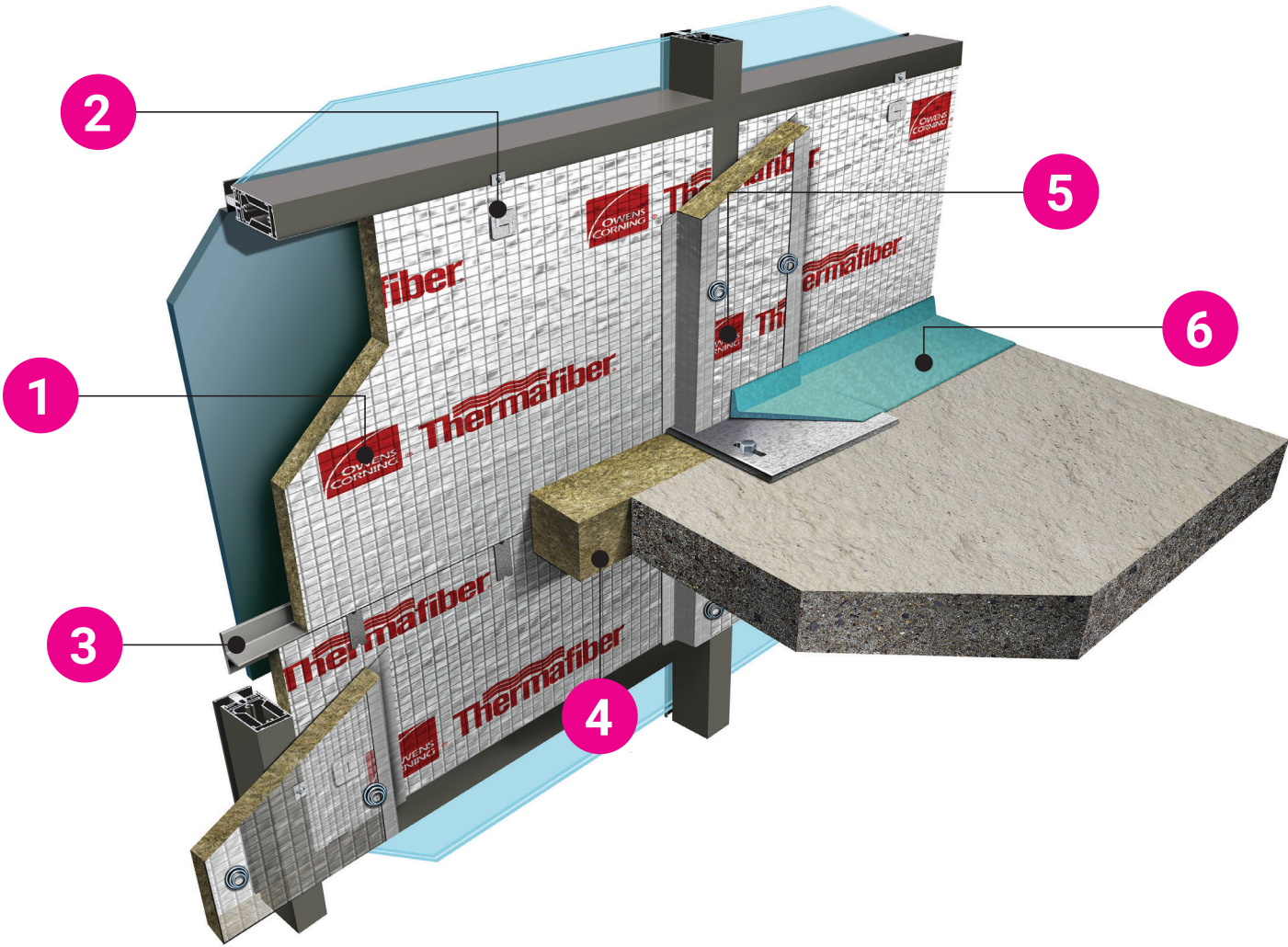

1 **Thermafiber® FireSpan® 90 or 40 mineral wool insulation at the specified thickness**

- Mineral wool insulation is mechanically attached within the spandrel opening.
- Mineral wool is the only insulation material that has been tested and proven to protect spandrel wall components (5 hours of fire exposure at temperatures over 2,000°F).
- Mineral wool insulation must be tested and approved in UL® or Intertek® designs per ASTM E2307.
- See specific UL® or Intertek® listing for specific FireSpan® product to be used.

2 **Mechanical attachment of insulation to the spandrel framing with Thermafiber® Impasse® Hanger**

- During a fire, there is a lot of turbulence, movement, and gravitational pull.
- Without mechanical fasteners, the insulation will become dislodged, allowing fire to propagate to the next floor.
- See specific UL® or Intertek® listing for specific fasteners and spacings to be used.

3 **Backer/reinforcement member**

- A backer bar reinforcement member, which can be a lightweight steel angle, T-bar, or hat channel, is placed behind the curtain wall insulation in line with the floor slab. See UL® or Intertek® listings for details.
- These support members are required to be a minimum 20 ga. galvanized steel (unless listing calls for a specific gauge).
- The backer/reinforcement member keeps the curtain wall insulation from bowing due to the compression-fit of the safing insulation.
- There are a few listings that do not require a backer/reinforcement member, but another reinforcement method is required in these assemblies. Reference the tested and listed system for specifics on providing the proper reinforcement at the safing line.

4 **Compression-fit Thermafiber® Safing mineral wool insulation**

- This forms a tight seal in the interior void — the area that is required by code to be sealed so that flame and hot gases cannot pass through the joint.
- It is important to install Thermafiber® Safing insulation at the proper depth and compression to keep this tight seal.
- Tested and listed assemblies provide direction on the amount of compression and in which direction the Thermafiber® Safing insulation is to be installed.
- Mineral wool insulation must be tested and approved in UL® or Intertek® designs per ASTM E2307.

5 **Thermafiber® FireSpan® 90 Mullion Covers to protect exposed vertical mullions**

- Aluminum will melt at 1,220°F, or as early as 9 minutes into a fire.
- If left exposed, aluminum framework will melt and cause an early failure in the system.
- Protect vertical mullions with Thermafiber® FireSpan® 90 Mullion Cover insulation.
- Thermafiber® Mullion Cover Insulation attached with either Thermafiber® Spiral Anchors every 12 inches o.c. or with patented Thermafiber® Mullion Cover Brackets.

6 **Smoke barrier**

- Smoke inhalation is responsible for the majority of fire-related deaths.
- To impede the passage of smoke, apply an approved smoke barrier over the top of the safing mineral wool insulation.
- See specific UL® or Intertek® listing for approved smoke sealants.

CRITICAL COMPONENTS OF A LISTED STEEL-FRAMED PERIMETER FIRE CONTAINMENT ASSEMBLY

For a perimeter fire containment assembly to work properly and meet code requirements, certain critical design elements must be included.

Steel-Framed Curtain Wall System

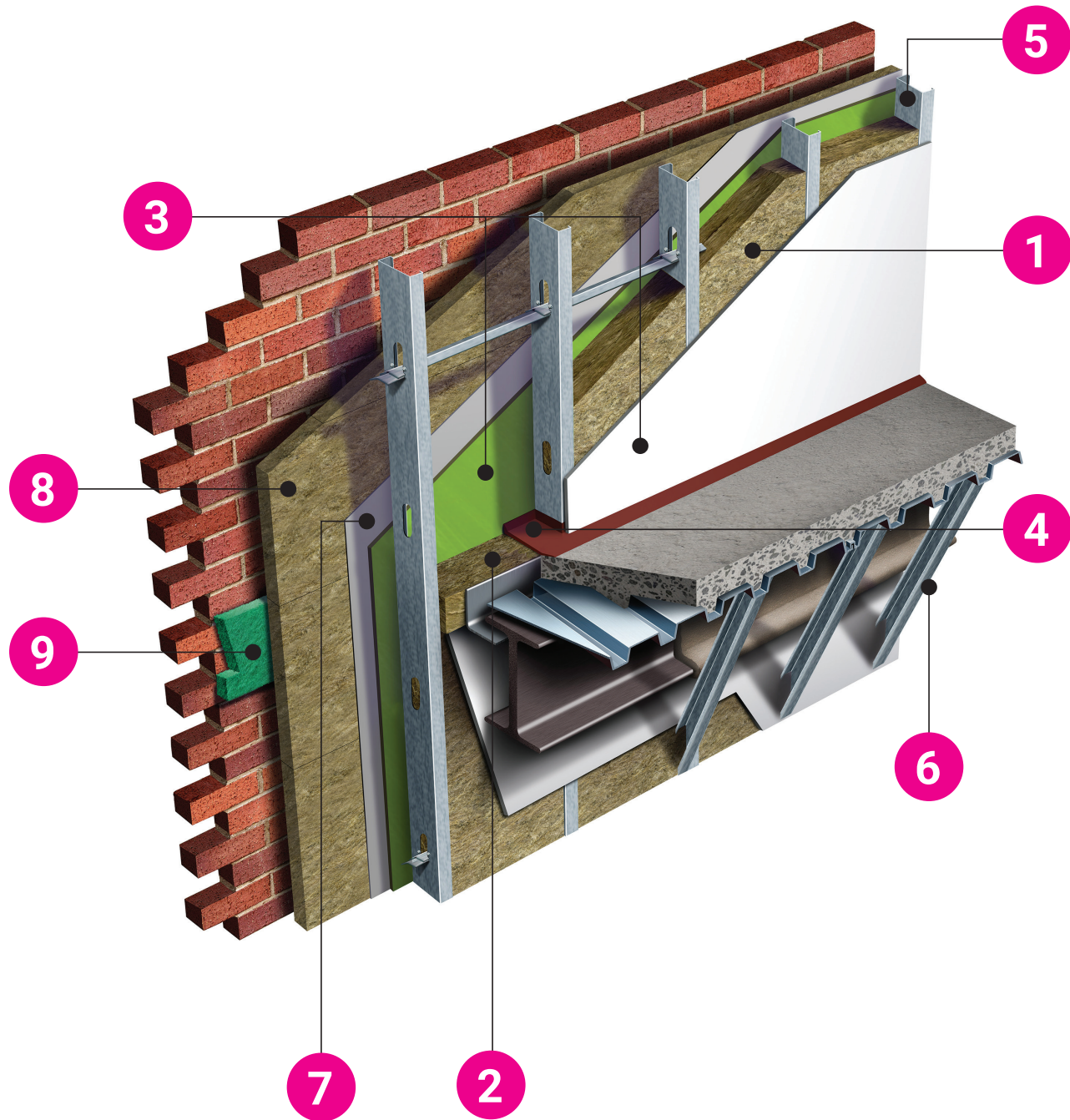

1 Thermafiber® FireSpan® 90 Mineral wool insulation (Requirement of a PFC System)

- Thermafiber® FireSpan® 90 Mineral Wool is friction-fit for full-cavity depth between steel framing.
- Mineral wool insulation must be tested and approved in UL® or Intertek® designs per ASTM E2307.

2 Installation of Thermafiber® Safing insulation by compression-fit (Requirement of a PFC System)

- The steel struts, in conjunction with the angled steel strut, also reinforces the studs against bowing during fire exposure and ensures the compression of the mineral wool safing will be secure.
- A minimum 25% compression fit is recommended to create a tight seal that maintains integrity, preventing flames and hot gases from breaching through to the floor above.
- Mineral wool insulation must be tested and approved in UL® or Intertek® designs per ASTM E2307.

3 Exterior grade gypsum wall board (Requirement of a PFC System)

- Exterior gypsum wall board is screw-attached to the exterior face of steel studs.

Interior grade gypsum wall board (Requirement of a PFC System)

- Interior gypsum wall board is screw-attached to interior face of steel studs.
- See specific UL® or Intertek® design for approved gypsum wall board. Approved smoke sealant.

4 Approved smoke sealant (Requirement of a PFC System)

- Applied to the top of the safing insulation to impede the passage of smoke.
- The smoke sealant is commonly spray-applied to the top of the safing insulation.
- A ½-inch overspray is usually specified to extend the smoke seal onto the floor slab on one side and the gypsum board surface on the other, creating a continuous seal that impedes passage of smoke.
- See Specific UL® or Intertek® design for approved smoke sealants.

5 Min 3 5/8", 20 gauge steel studs (Requirement of a PFC System)

6 Steel struts attaching exterior wall to floor assembly (Requirement of a PFC System)

Optional Components for Continuous Insulation System:

7 Air and Water Barrier

8 Continuous Insulation: Thermafiber® RainBarrier® 45, RainBarrier® HD, or RainBarrier® ci High Compressive insulation

9 Mortar dropping collection device

OUR MOST COMMON PERIMETER FIRE CONTAINMENT SYSTEMS

Thermafiber, Inc. has identified trends in perimeter exterior wall designs, and has developed and tested perimeter fire containment solutions for these popular designs. These fire containment solutions are engineered to be code-compliant without compromising design.

TFI/BPF 120-15 AND 180-07

Thermafiber® Impasse® Zero Spandrel Perimeter Fire Containment System

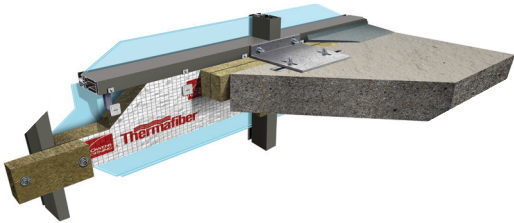

- Patent-pending design that revolutionizes the way zero spandrel systems are built with sturdier Thermafiber® FireSpan® 120 mineral wool insulation and heavy-duty Thermafiber® Impasse® 2.0 Hanger technology.
- 2- and 3-hour F rating.
- This robust system eliminates the need for costly and bulky back pans, accommodates various curtain wall anchors, allows for less penetrations in the curtain wall framing, and offers flexibility for various shadowbox designs.⁵
- Easier installation for both field and shop installed curtain walls over current available zero spandrel systems.⁵
- For system-specific documentation and resources, visit the [TFI/BPF 120-15 and 180-07 Perimeter Fire Containment System Enclosure Solution](#).

This Perimeter Fire Containment System is available in formaldehyde-free mineral wool formulation. For system-specific documentation and resources, visit the [TFI/BPF 120-15 and 180-07 Formaldehyde-Free Perimeter Fire Containment System Enclosure Solution](#).

CW-D-1014 THROUGH 1017

Thermafiber® Impasse® No Backer Bar™ Aluminum-Framed Curtain Wall Perimeter Fire Containment System

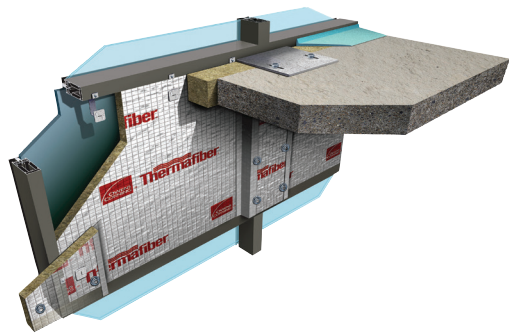

- This patented Impasse® system offers a no backer bar design with the extension of the vision glass down to the top of the floor.
- 2-hour F rating.
- Fewer mechanical fasteners required vs. traditional systems.
- Provides significant labor savings.
- No backer/reinforced member required when window sill transom is inline or spaced a maximum of 3 inches above the top of floor slab.
- For system-specific documentation and resources, visit the [CW-D-1014 Through 1017 Perimeter Fire Containment System Enclosure Solution](#).

This Perimeter Fire Containment System is available in formaldehyde-free mineral wool formulation. For system-specific documentation and resources, visit the [CW-D-1014 Through 1017 Formaldehyde-Free Perimeter Fire Containment System Enclosure Solution](#).

CW-D-1012 THROUGH 1013

Thermafiber® Impasse® No Backer Bar™ with FireLedge® Aluminum-Framed Curtain Wall Perimeter Fire Containment System

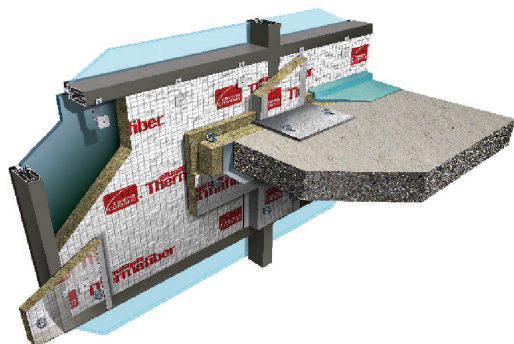

- This patented Impasse® system eliminates the labor-intensive installation of a mechanical backer reinforcement member by utilizing a rigid mineral wool Thermafiber® FireLedge® component to support the compressed Thermafiber® Safing insulation and provide a secure fire containment at the interior joint.
- 2-hour F rating and 3-hour F rating.
- For system-specific documentation and resources, visit the [CW-D-1012 Through 1013 Perimeter Fire Containment System Enclosure Solution](#).

CW-D-2039

Thermafiber® Impasse® Aluminum-Framed Curtain Wall Perimeter Fire Containment System

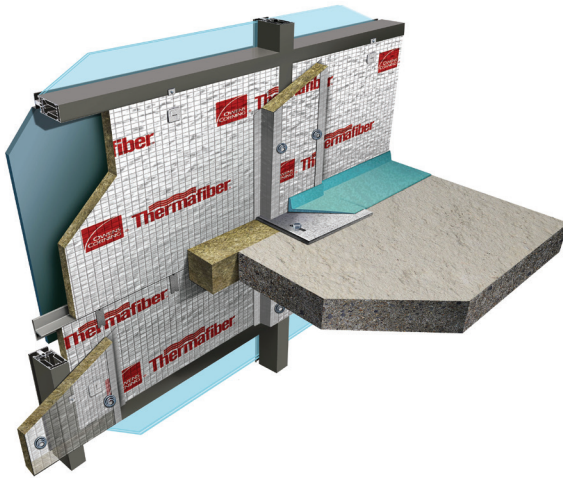

- This patented Impasse® system offers a solution for providing necessary backer reinforcement in assemblies where the floor slab is located mid-spandrel height.
- 2-hour F rating and Integrity Rating.
- Fewer mechanical fasteners required vs. traditional systems.
- For system-specific documentation and resources, visit the [CW-D-2039 Perimeter Fire Containment System Enclosure Solution](#).

CW-S-1016

Thermafiber® Steel-Framed Curtain Wall Perimeter Fire Containment System

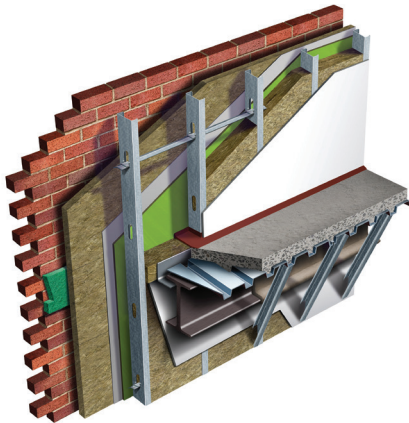

- This system offers a solution for a steel stud exterior wall that bypasses the rated floor assembly.
- 2-hour F and Integrity rating.
- For system-specific documentation and resources, visit the [CW-S-1016 Perimeter Fire Containment System Enclosure Solution](#).

CW-D-1037

Thermafiber® Aluminum-Framed Curtain Wall Perimeter Fire Containment System with Galvanized Steel Back Pan

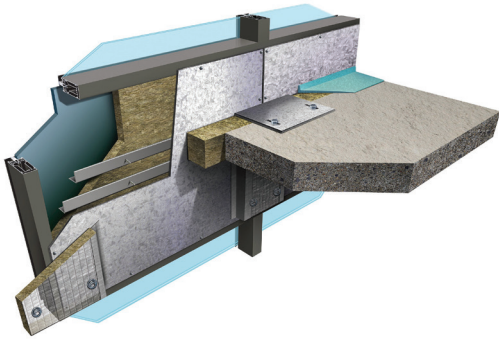

- This system offers interior back pan protection without the need for additional insulation shelf below the safin.
- 2-hour F and Integrity rating.
- Does not require stitch-welding the T-bar to the steel back pan.
- No mullion covers required above the floor slab.
- For system-specific documentation and resources, visit the [CW-D-1037 Perimeter Fire Containment System Enclosure Solution](#).

TFI/BPF 120-16 AND TFI/BPF 120-17

Thermafiber® Crimped Backpan Perimeter Fire Containment System

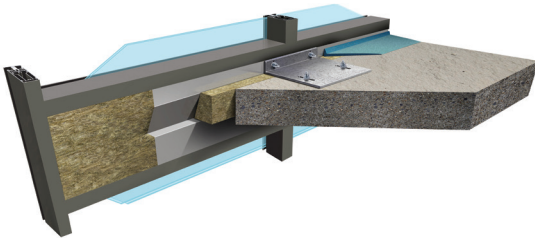

- This patent pending design with a crimped interior backpan simplifies installation and allows for easier visual identification of system components during inspection.
- 2-hour F rating and Integrity rating.
- Eliminates need for backer reinforcement member.
- Eliminates mullion covers.
- For system-specific documentation, visit the [TFI/BPF 120-16 and TFI/BPF 120-17 Perimeter Fire Containment System Enclosure Solution](#).

This Perimeter Fire Containment System is available in formaldehyde-free mineral wool formulation. For system-specific documentation and resources, visit the [TFI/BPF 120-16 and TFI/BPF 120-17 Formaldehyde-Free Perimeter Fire Containment System Enclosure Solution](#).

SMOKE SEALANTS

Since smoke inhalation is responsible for the majority of fire-related deaths⁸, most perimeter fire containment systems tested at UL[®] and Intertek[®] evaluate the air leakage rate through the interior joint. The air leakage is rated in CFM per square foot at both ambient and at 400°F.

To help control smoke passage through the interior joint, an approved smoke sealant is applied over top of the safing insulation. The function of a smoke sealant is to impede the passage of toxic smoke. It is always applied on the non-fire-exposed side of the perimeter fire containment system.

Smoke sealants are typically an elastometric, spray-applied material that extends onto the curtain wall insulation and floor assembly to form a barrier against the leakage of smoke through the safe-off joint.

Approved smoke sealant manufacturers are specifically listed in the UL[®] or Intertek[®] perimeter fire containment system listings.

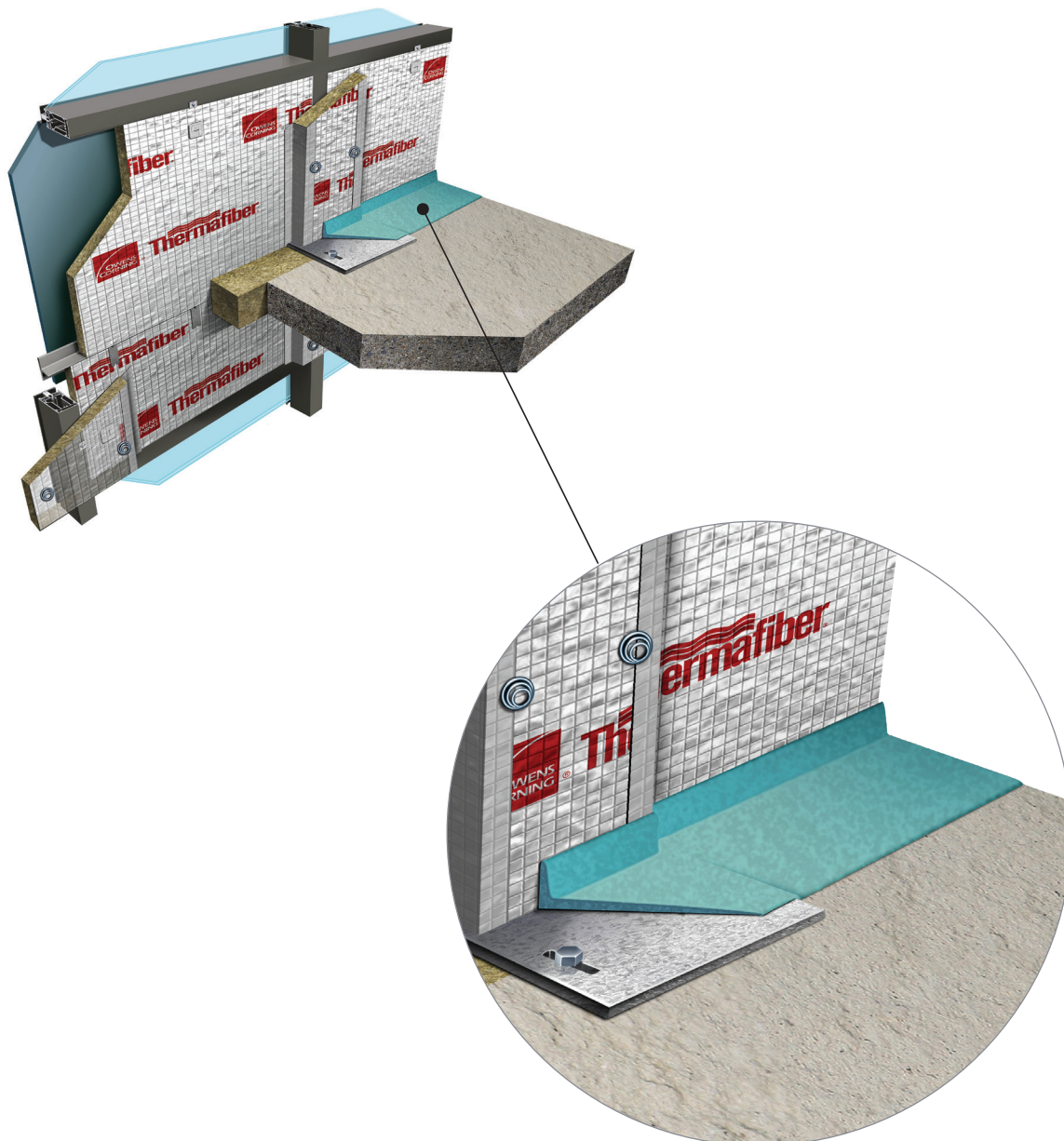

SPANDREL REQUIREMENTS

The perimeter fire containment system must address the particular spandrel material. A system designed for one type of spandrel material can't be utilized for addressing the fire protection of another type of spandrel material.

Additional Requirements to Know:

- A specific amount of spandrel protection is required below the safe-off area. This detail is required to preserve a portion of the exterior wall so that safing remains securely in place.
- Additional reinforcement and mechanical attachment is required for shorter spandrels.
- Composite panels and spandrel material used must be evaluated per ASTM E2307 or NFPA 285 for non-combustibility. Untested components of the spandrel assembly could cause a potential failure during a fire event.
- Safing insulation must be installed up to a steel back pan with reinforcement. If a steel back pan is used, proper reinforcement and mechanical attachment of the curtain wall insulation is required.
- A 1-inch air space is required between the curtain wall insulation and the interior face of the spandrel glass.
- Additional curtain wall insulation can be added to the spandrel area to improve the overall thermal performance of the assembly. If this is the case, re-evaluation by Thermafiber Insolutions® of the mechanical attachment and support of the spandrel insulation that serves as the primary fire containment is required.

SPECIAL CONDITIONS

We recognize there are situations where there are special conditions to consider while designing and installing perimeter fire containment systems. The following considerations have to be incorporated in the design in order for the perimeter fire containment system to perform to the stated hourly fire rating.

Wider Spandrel Conditions

- There is no current method of evaluating this condition since there is a limitation with the test apparatus in ASTM E2307.
- Anything wider than 72 inch on curtain wall center requires further evaluation since there are manufacturing limitations on width of insulation.
- Most systems do not allow for vertical seam; of the few assemblies that allow for it, additional considerations are required:
 - **4 inches thick or greater Thermafiber® FireSpan® 90 or 40 curtain wall insulation**
 - **All are hat channel designs with multiple horizontal steel structural members**
- Considerations for a vertical seam:
 - **Unsupported vertical seams in the curtain wall insulation can open up during a fire, where insulation shrinkage can occur**
 - **Since seams continue to open up through the interior joint behind the safing insulation, this allows for fire to pass through the safing line**
 - **No framing member for mechanical attachment**
- Wider spandrel conditions are evaluated with recommendations provided by the Thermafiber Insolutions® team on a project-by-project basis.
- UL®-approved solutions are available from Thermafiber, Inc.

Steel Back Pans

Steel back pans are becoming quite common because of the popularity of unitized systems. The steel back pan is installed as the vapor barrier to the system, but these systems can have issues if not properly protected. Even though steel does not melt when exposed to heat, the pan will “oil can” (buckle), creating peaks and valleys due to the expansion and contraction of the panel when exposed to high temperatures during a fire. Unfortunately, the safing insulation cannot conform to the panel's peaks and valleys. Small seams form at the safing line, which allows flames and hot gases to propagate to the next floor. There are specific UL® or Intertek® systems that address the protection of these systems. These can be found in the UL® or Intertek® Fire Resistance Directory. Intertek® or UL®-approved mineral wool must be used in these back pans to show that they meet ASTM E2307. Not just any mineral wool insulation will do. Look for the UL® or Intertek® classification marking.



This depiction shows how improperly installed steel back pan assemblies perform when exposed to the fire conditions of ASTM E2307.

Basic steel back pan with spandrel insulation on the inside of the back pan

This is an example of a shadowbox assembly where the pan is on the front (glass) side of the assembly and is purely cosmetic.

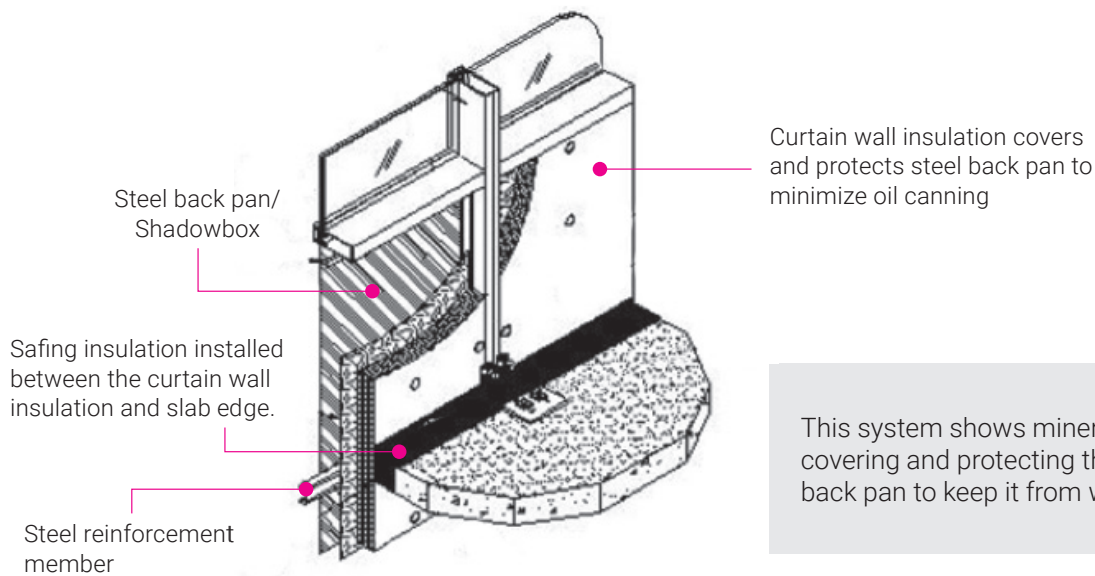

This system shows mineral wool covering and protecting the steel back pan to keep it from warping.

Steel back pan with spandrel insulation to the outside of the back pan with safing shelf

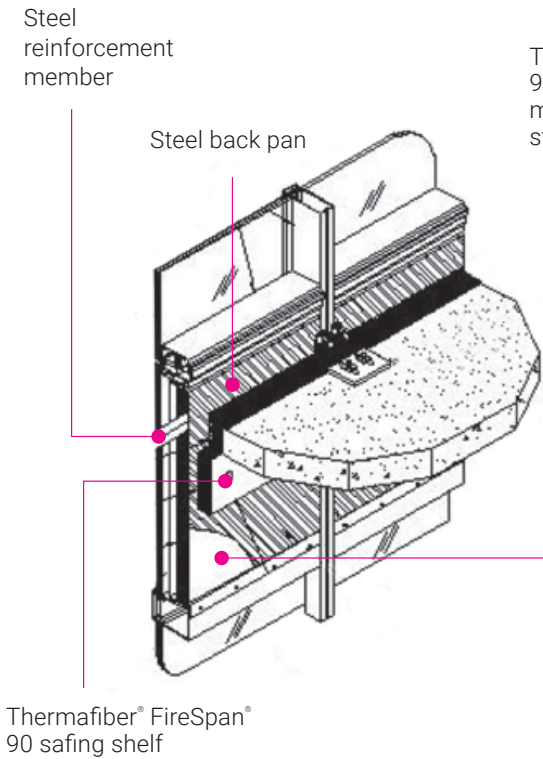

This system shows a Thermafiber® FireSpan® 90 safing shelf installed to steel back pan. The safing shelf moves with the steel back pan to cover and protect any seams forming between interface of steel back pan and Thermafiber® Safing insulation. This shelf covers the seam between the interior face of the back pan and the Thermafiber® Safing. If peaks and valleys occur, the seam is covered by the safing shelf.

Steel back pan with spandrel insulation to the outside of the back pan without safing shelf

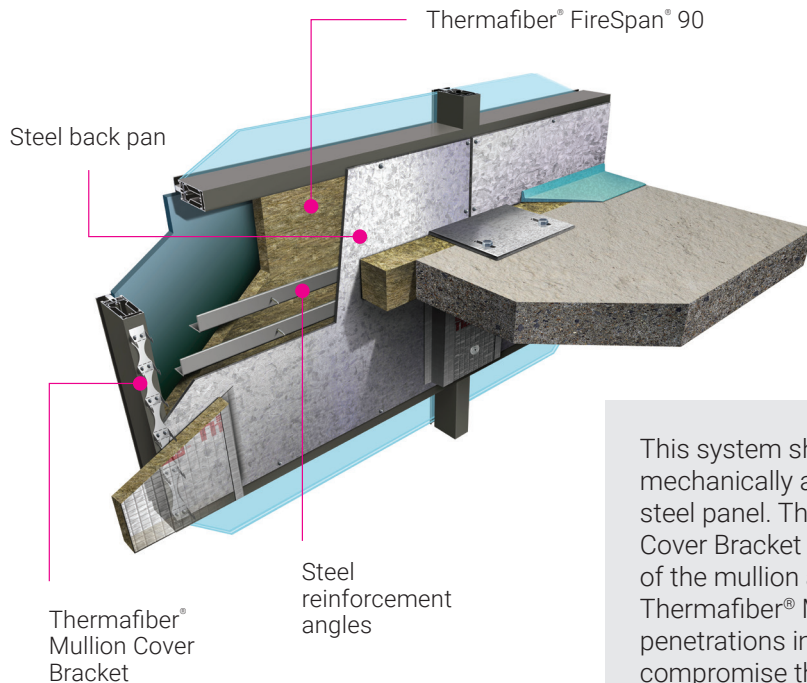

This system shows Thermafiber® FireSpan® 90 mechanically attached to the outboard side of the steel panel. The patented Thermafiber® Mullion Cover Bracket is mechanically secured to the face of the mullion above and below the floor slab. The Thermafiber® Mullion Cover Bracket eliminates penetrations into the back pan which could compromise the vapor barrier.

This assembly does not require stitch-welding the T-bar to the steel back pan, and no mullion cover is required above the floor slab.

Curved Spandrel Walls

- There is no tested or listed assembly for curved curtain walls.
- Conformance of spandrel insulation to the arc depends on degree of radius
- Limited mechanical attachment options are available
 - High-cost custom mechanical fasteners are typically required
- Custom support members:
 - Radius backer reinforcement is required in front of the spandrel insulation with same arc as the slab
 - Accommodations are required where there are varied joint widths between slab and spandrel insulation
- Curved spandrel conditions are evaluated with recommendations provided by the Thermafiber Insolutions® team on a project-by-project basis.

Curtain spandrel wall

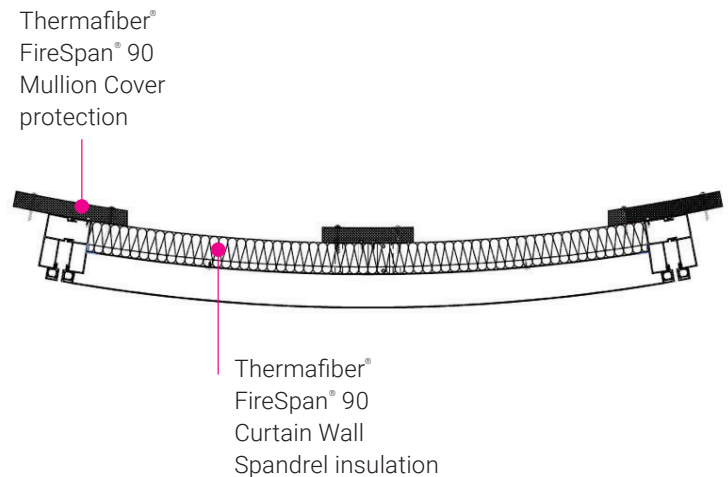

Angled Spandrel Walls

- Limited systems are available and very specific to a particular condition.
- Limited mechanical attachment options are available.
 - High-cost custom mechanical fasteners required
- Custom support members are often required.
- Considerations include:
 - Securing the safing insulation in the linear joint
 - Flame impingement: more fire exposure to spandrel when angling out
 - Varying linear joint widths create difficulty in achieving safing compression requirements
 - May require mechanical attachment to keep the safing insulation from dislodging over lifetime of the building
- Angled spandrel conditions are evaluated with recommendations provided by the Thermafiber Insolutions® team on a project-by-project basis.

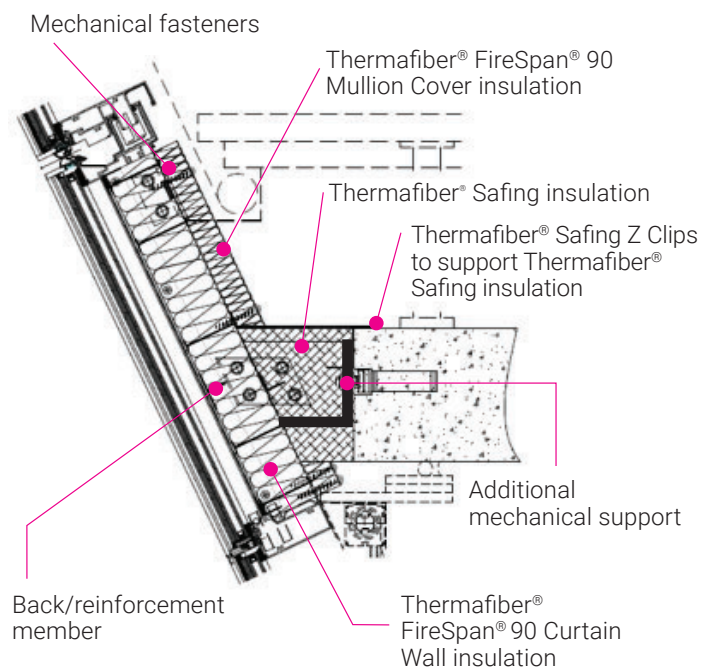

Exposed Curtain Wall Anchors at the Floor Line

- There is currently no method of evaluating load-bearing curtain wall anchors in ASTM E2307 testing.
- The UL Fire Resistance Directory states: “Curtain wall spandrel panel dead load anchors located below the concrete floor should be protected from direct fire exposure.”
 - Unprotected curtain wall anchors exposed below the floor line create a higher probability of complete system failure.
 - Curtain wall anchors exposed to 400° to 500°F heat will lose close to half of their structural strength.
- UL has created a new category (XHDI) for perimeter fire containment accessories, which includes an anchor protection component.
- Recommended protection of curtain wall anchors is provided by Thermafiber Insolutions® Team on a project-by-project basis.

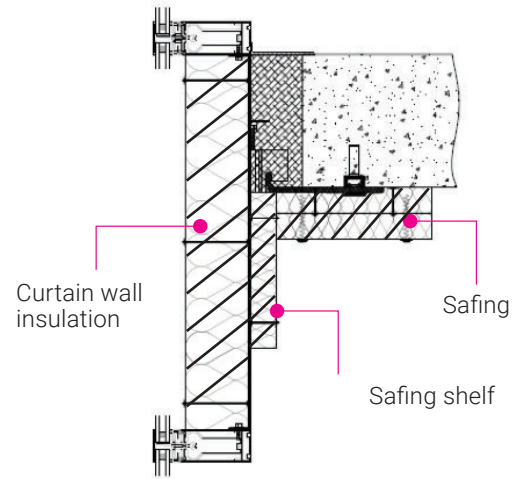

Exposed curtain wall anchors at the floor line protected by mineral wool insulation. Thermafiber, Inc. recommends a minimum 4-inch thickness of Firespan® 90, 40, or Safing insulation be mechanically attached to cover and protect exposed curtain wall anchors and attachment points at vertical mullions.

COMBUSTIBLE BUILDING MATERIALS USED IN PERIMETER FIRE CONTAINMENT SYSTEMS

Requirements for exterior walls containing combustible materials in the IBC

MATERIAL	CODE SECTION
Foam plastic insulation	2603.5
Metal composite materials (MCM)	1407.10
Fiber-reinforced polymers	2612.6
High-pressure laminates (HPL)	1409.10
Water-resistive barrier	1403.5

Considerations:

- Provide additional fuel load under fire conditions
- Untested exterior facade panels
 - Unknown panel performance when exposed to ASTM E2307 conditions should be NFPA 285 compliant, at the very least
 - Should be attached independent from the perimeter fire containment system
 - Should not rely on structural support of the perimeter fire containment system
- May require Engineering Judgment addressing both ASTM E2307 and NFPA 285 compliance
- Other untested building materials
 - Materials with known fuel sources should not be installed in perimeter fire containment assemblies to achieve targeted thermal values

STANDARD FIRE TEST METHOD FOR EVALUATING FIRE PROPAGATION CHARACTERISTICS OF EXTERIOR WALL ASSEMBLIES CONTAINING COMBUSTIBLE COMPONENTS

NFPA 285

The NFPA 285 fire test was developed to measure what happens during a fire when a non-combustible building is wrapped in combustible materials. For example, NFPA 285 compliance is triggered when the IBC requires non-combustible wall construction; however, the energy code requires:

- Air/water-resistive barriers, often combustible, and/or
- Continuous insulation, often combustible, or
- Perhaps a combustible exterior cladding is specified.

According to the IBC, NFPA 285 compliant wall assemblies are usually required when combustible elements are incorporated into Types I, II, III, and IV construction, which are intended to feature non-combustible walls.

- **Types I and II:** All building elements are of non-combustible materials.
- **Type III:** Exterior walls of non-combustible materials and the interior elements are of any material permitted by the code.
- **Type IV:** Heavy timber, exterior walls of non-combustible materials, and the interior elements are of solid or laminated wood without concealed spaces.
- **Type V:** Exterior walls and interior building elements are of any material permitted by the code.

Conducting an NFPA 285 Fire Test

NFPA 285 is an intermediate scale fire test. It's conducted in a rig roughly 14 feet wide, 18 feet high, and two stories tall. Thermocouples are located throughout the assembly, and a fixed gas burner is in the center of the lower room. After the test gets underway, a portable gas burner is ignited in the window opening. The assumption is that a fire starts in a lower room unrelated to the exterior wall. There's no window in the opening during the test because the test seeks to demonstrate the point in a fire after the window is compromised. The test monitors temperature flame propagation on the exterior, within the core, and over the interior surface from one floor to the next.

To pass an NFPA 285 Fire Test, the wall assembly must limit fire spread vertically and horizontally away from the window. The extent of fire spread is determined visually, measured in feet, and by temperature measured with thermocouples placed throughout the wall assembly.

ENGINEERING JUDGMENTS

International Firestop Council (IFC)



RECOMMENDED IFC GUIDELINES FOR EVALUATING FIRESTOP SYSTEMS IN ENGINEERING JUDGMENTS

Perimeter Fire Barrier Systems

The International Firestop Council, IFC, is a not-for-profit association of manufacturers and users of fire protective materials and systems. IFC's mission is to promote the technology of fire containment in modern building construction through research, education programs, and the development of safety standards and code provisions. These recommended guidelines are presented as part of the IFC's educational information program. They are for informational and educational purposes.

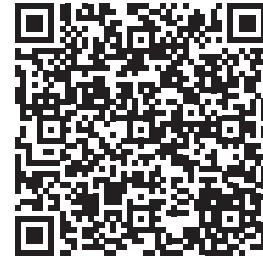

SCAN TO LEARN MORE ABOUT ENGINEERING JUDGMENTS

THE CRITICAL COMPONENTS OF ENGINEERING JUDGMENTS FOR PERIMETER FIRE CONTAINMENT

Thermafiber, Inc. has identified the following critical components when providing a quality engineering judgment for perimeter fire containment systems:

1. The engineering judgment must be project-specific and represent the project conditions being evaluated.
2. At least one third-party tested system (evaluated to ASTM E2307 or appropriate standard based on requirement of the applicable jurisdiction) that most closely represents the project construction details must be referenced as the basis of design in order to properly evaluate the hourly F rating.
3. Engineering judgments must provide a complete description of the critical elements of the system and must include the tested and listed system's design criteria that are required to make the system work.
The engineering judgment must be based on interpolation of previously tested perimeter fire containment systems that are similar to the conditions upon which the judgment is given.
4. An engineering judgment should not be used as a way to circumvent testing new fire containment assemblies. Engineering judgments that do not have data to interpolate and/or extrapolate, within the boundaries of good design practices of the condition in question, should initiate the need for fire testing.
5. An engineering judgment must state that, it is such and not a tested and listed system.
6. It is important to understand that although it is the void between the slab edge and curtain wall that is evaluated during testing, the surrounding construction components and insulation of the system is also important in ensuring acceptable void performance.

In addition to the critical components of engineering judgments highlighted above, Thermafiber strongly abides by the International Firestop Council (IFC)-provided recommendations on writing engineering judgments, titled "Recommended IFC Guidelines for Evaluating Firestop Systems in Engineering Judgments." Below is an outline of several of the requirements (not all included here) for engineering judgments:

- All elements of a tested and rated firestop system, including the assembly into which the system is installed, constitute a specific and inseparable engineered unit that must be utilized as such. Firestop system designs are tested and listed by independent testing agencies such as UL® and Intertek. The specific elements of each design become integral to the listing.
- According to the IFC, engineering judgments should be based upon interpolation of previously tested firestop systems that are either sufficiently similar in nature or clearly bracket the conditions upon which the judgment is to be given.
- Engineering judgments should be limited only to specific conditions and configurations upon which the engineering judgment was rendered and should be based upon reasonable performance expectations for the recommended firestop system under those conditions.

For more information, reference the [IFC's guidelines](#).

PIONEERS IN IMPROVING BUILDING SAFETY

In 2017, several Thermafiber® and Owens Corning® insulating materials and services became the first building products to earn the U.S. Department of Homeland Security's SAFETY Act Designation, providing architects and related parties with protection against liability related to acts of terrorism.

What is SAFETY Act Designation?

- In 2002, Congress enacted the Support Anti-Terrorism by Fostering Effective Technologies (SAFETY) Act to encourage deployment of security technologies and services in civilian settings.
- The SAFETY Act limits liability for claims resulting from an act of terrorism where Qualified Anti-Terrorism Technologies (QATTs) are deployed.
- The Act applies to a broad range of technologies, including products, services, and software, alone or in combination.



Thermafiber® SAFETY Act Designated products and services

Perimeter Fire Containment Systems and Components

- Thermafiber® FireSpan® 40 & 90
- Thermafiber® Safing
- Thermafiber® Impasse® PFC System
- Thermafiber Insolutions® Design and Installation Services

Construction Joint Fire Containment Systems

- Thermafiber® Safing
- Thermafiber® TopStop®

Penetration Fire Containment Systems

- Thermafiber® Safing

Interior Wall/Floor/Ceiling Systems

- Thermafiber® SAFB™
(Sound Attenuation Fire Blankets)

How does choosing Thermafiber® SAFETY Act Designated products and services help protect your building and reduce liability?



Building owners

When your building is constructed with SAFETY Act Designated Thermafiber® products and services, you get peace of mind knowing your building contains insulation with the highest ratings for perimeter fire containment.



Architects • Firestop Contractors • Curtain Wall OEMs

Specifying and properly installing a Thermafiber® product that carries the SAFETY Act Designation limits your liability in the event of an act of terrorism.



Tenants and occupants

Buildings constructed with SAFETY Act Designated Thermafiber® products have an enhanced life safety system.

Already used a Thermafiber® SAFETY Act Designated product in a previous project?

Your liability protection applies to projects dating back to 2006.

PROJECT SPOTLIGHT



Thermafiber® Perimeter Fire Containment Systems components and Thermafiber® Insolutions® Design and Installation Services have been awarded SAFETY Act Designation by the U.S. Department of Homeland Security (DHS). Under the SAFETY Act, commercial building professionals – including architects, engineers, contractors (both general and firestopping), smoke sealant manufacturers, curtain wall OEMs, as well as building owners – who use the the Thermafiber® SAFETY Act Designated® solutions in their structures will receive powerful liability protection in the event of a foreign or domestic terrorist attack on that building. Visit SafetyAct.gov for more info.



SALESFORCE TOWER | San Francisco, California

At 1,070 feet tall, the 61-story obelisk Salesforce Tower located in San Francisco's Financial District is now considered the tallest building in California. Completed in early 2018, the \$1.1 billion Salesforce Tower is a visually stunning achievement in sustainable design strategy. The Pelli Clarke Pelli Architects design team incorporated the easy-to-install Thermafiber® Impasse® Curtain Wall Perimeter Fire Containment System to streamline the installation of curtain wall insulation and take full advantage of the fire-resistive, enhanced acoustical performance, and vapor barrier properties of Thermafiber® FireSpan® 90 insulation and Safing insulation. The Impasse® system is tested and rated with UL® laboratories and provides up to 3* hours of fire containment.



181 FREMONT | San Francisco, California

Designed by Heller Manus Architects, 181 Fremont is a mixed-use skyscraper located in San Francisco's Financial District. Standing more than 800 feet tall and 70 stories, 181 Fremont is now considered the tallest residential building on the West Coast and third-tallest building in San Francisco. Targeted to achieve a LEED Platinum certification, the 181 Fremont design incorporates innovative design strategies for sustainability and energy efficiency. The customized Thermafiber® Impasse® solution incorporated Thermafiber® FireSpan® 90 insulation and Thermafiber® Safing insulation for enhanced fire protection in curtain wall and perimeter fire containment.



VIA 57 WEST | New York, New York

Completed in 2016, VIA 57 West has earned multiple awards, including 2016 Best Tall Building, Americas by the Council on Tall Buildings and Urban Habitat (CTBUH), 2015 Progressive Architecture Citation Award, and 2012 NY AIA Merit Award. The 830,000 sq. ft. high rise residential building features a lush 22,000 sq. ft. European-inspired courtyard at the heart of the building. This unique building was designed by Bjarke Ingels Group (BIG) architectural firm and includes multiple Thermafiber® solutions, including FireSpan® 90 insulation, Safing insulation, RainBarrier® 45 insulation, and SAFB® (Sound Attenuation Fire Blanket) insulation.



WILSHIRE GRAND | Los Angeles, California

Located in downtown Los Angeles' Financial District, the 73-story Wilshire Grand tower soars to a height of 1,100 feet, making it LA's tallest skyscraper. Architecture firm AC Martin designed the \$1.2 billion structure that earned LEED Gold certification after opening in 2017. The Thermafiber® Impasse® System solution was selected to help streamline the installation of curtain wall insulation and take full advantage of the fire-resistive, enhanced acoustical performance, and vapor barrier properties of Thermafiber® FireSpan® 90 insulation and Safing insulation.



380 MADISON AVE. | New York City, New York

The 380 Madison office building, located in the heart of New York City's Midtown, used Thermafiber® Mineral Wool insulation, including Thermafiber® FireSpan® 90 and Thermafiber® Safing solutions in the construction of the 25-story, 859,000 square-foot building. Architects Kohn Pedersen Fox Associates (KPF) dramatically transformed the existing tower that was previously known as 380 Madison into a modernized tower with new energy-efficient curtain walls. The redesign earned a Merit Award from the AIA New York 2016 awards and received LEED Gold Certification.



THE STEINY TOWER | New York City, New York

Designed by SHoP Architects, the 1,400-foot, 82-floor residential tower in New York City has the distinction of being the world's skinniest skyscraper. Completed in 2018, the project incorporated Thermafiber® FireSpan® 90 insulation to provide enhanced fire protection in curtain wall and perimeter fire containment systems. With 70% recycled content, Thermafiber® Mineral Wool insulation also contributed to the project's overall sustainable goals of earning LEED CS Gold certification.



7 BRYANT PARK | New York City, New York

Located in Midtown Manhattan, the sleek 30-story glass-and-stainless-steel building was designed by architect Henry N. Cobb of the firm Pei Cobb Freed & Partners. The \$150 million 7 Bryant Park project incorporates a unique curtain wall that utilized the Thermafiber® Impasse® System, including Thermafiber® FireSpan® 90 and Thermafiber® Safing, to help save time and money over traditional job site installation methods and deliver enhanced fire protection performance in the curtain wall and perimeter fire containment. Due to the minimum of 70% recycled content, the Thermafiber® Impasse® System also helped the project achieve LEED certification at the Gold level upon its completion in 2016.



1 WORLD TRADE CENTER | New York City, New York

The 1 World Trade Center architectural firm, Skidmore, Owings and Merrill, selected Thermafiber® FireSpan® 90 insulation for use in conjunction with Thermafiber® Safing insulation to achieve outstanding fire protection in curtain wall and perimeter fire containment systems. Additionally, a custom designed Thermafiber® Impasse® Insulation Hanger System was utilized to make installation simple, accurate, and fast. This collection of products with a minimum of 70% recycled content contributed to project's overall sustainable goals and helped earn the building LEED Gold Certification.



To learn more about Thermafiber® perimeter fire containment products and systems, visit www.owenscorning.com/pfc.



THERMAFIBER, INC.
ONE OWENS CORNING PARKWAY
TOLEDO, OH 43659 USA

888-TFIBER1 [834-2371]
www.owenscorning.com/thermafiber

Pub. No. 10022722-C. Printed in U.S.A. September 2024.
© 2024 Owens Corning. All Rights Reserved.
© 2024 Thermafiber, Inc. All Rights Reserved.

The color PINK is a registered trademark of Owens Corning.
UL® and the UL logo are trademarks of UL LLC.
INTERTEK and the Intertek logo are registered trademarks of Intertek Group plc.

References

- 1 "About the U.S. Fire Administration." www.usfa.fema.gov/data/statistics/.
- 2 "USFA Nonresidential Build Fire Trends (2010-2019)." <https://www.usfa.fema.gov/data/statistics/nonresidential-fire-estimates/index.html>
- 3 "USFA Trends in fires, deaths, injuries, and dollar loss (2010-2019)." <https://www.usfa.fema.gov/data/statistics/>
- 4 Thermafiber, Inc. was a division of United States Gypsum Company (USG) from 1959-1996.
- 5 Based on comparison done with available competitive perimeter fire containment systems.
- 6 ASTM E119-12a, Standard Test Methods for Fire Tests of Building Construction and Materials; ASTM International, 100 Barr Harbor Drive, PO Box C700, West Conshohocken, PA, 19428-2959.
- 7 ASTM E2307, Standard Test Method for Determining Fire Resistance of Perimeter Fire containment Systems Using Intermediate-Scale, Multi-story Test Apparatus; ASTM International, 100 Barr Harbor Drive, PO Box C700, West Conshohocken, PA, 19428-2959.
- 8 Reporters Guide: NFPA The Consequences of Fire.